

Go to [www.vtechphones.com](http://www.vtechphones.com)  
to register your product for  
enhanced warranty support and  
latest VTech product news.

DS6291  
DS6291-2  
DS6291-3  
DS6292-5

DECT 6.0 cordless telephone  
with BLUETOOTH® wireless technology



**vtech**®

User's manual

## Congratulations

on purchasing your new VTech product. Before using this telephone, please read **Important safety instructions**.

This manual has all the feature operations and troubleshooting necessary to install and operate your new VTech telephone. Please review this manual thoroughly to ensure proper installation and operation of this innovative and feature rich VTech product.

For support, shopping, and everything new at VTech, visit our website at **www.vtechphones.com**. In Canada, please visit **www.vtechcanada.com**.



Telephones identified with this logo have reduced noise and interference when used with most T-coil equipped hearing aids and cochlear implants. The TIA-1083 Compliant Logo is a trademark of the Telecommunications Industry Association. Used under license.

**Register online to get an additional 3-month warranty!**

Visit **www.vtechphones.com**.

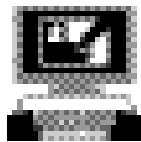

### Registration

Register your product online for enhanced warranty support.



### Product news

Learn about the latest VTech products.

## Important safety instructions

When using your telephone equipment, basic safety precautions should always be followed to reduce the risk of fire, electric shock and injury, including the following:

1. Read and understand all instructions.
2. Follow all warnings and instructions marked on the product.
3. Unplug this product from the wall outlet before cleaning. Do not use liquid or aerosol cleaners. Use a damp cloth for cleaning.
4. Do not use this product near water such as near a bath tub, wash bowl, kitchen sink, laundry tub or swimming pool, or in a wet basement or shower.
5. Do not place this product on an unstable table, shelf, stand or other unstable surfaces.
6. Slots and openings in the back or bottom of the telephone base and handset are provided for ventilation. To protect them from overheating, these openings must not be blocked by placing the product on a soft surface such as a bed, sofa or rug. This product should never be placed near or over a radiator or heat register. This product should not be placed in any area where proper ventilation is not provided.
7. This product should be operated only from the type of power source indicated on the marking label. If you are not sure of the type of power supply in your home or office, consult your dealer or local power company.
8. Do not allow anything to rest on the power cord. Do not install this product where the cord may be walked on.

9. Never push objects of any kind into this product through the slots in the telephone base or handset because they may touch dangerous voltage points or create a short circuit. Never spill liquid of any kind on the product.
10. To reduce the risk of electric shock, do not disassemble this product, but take it to an authorized service facility. Opening or removing parts of the telephone base or handset other than specified access doors may expose you to dangerous voltages or other risks. Incorrect reassembling can cause electric shock when the product is subsequently used.
11. Do not overload wall outlets and extension cords.
12. Unplug this product from the wall outlet and refer servicing to an authorized service facility under the following conditions:
  - When the power supply cord or plug is damaged or frayed.
  - If liquid has been spilled onto the product.
  - If the product has been exposed to rain or water.
  - If the product does not operate normally by following the operating instructions. Adjust only those controls that are covered by the operation instructions. Improper adjustment of other controls may result in damage and often requires extensive work by an authorized technician to restore the product to normal operation.
  - If the product has been dropped and the telephone base and/or handset has been damaged.
  - If the product exhibits a distinct change in performance.
13. Avoid using a telephone (other than cordless) during an electrical storm. There is a remote risk of electric shock from lightning.
14. Do not use the telephone to report a gas leak in the vicinity of the leak. Under certain circumstances, a spark may be created when the adapter is plugged into the power outlet, or when the handset is replaced in its cradle. This is a common event associated with the closing of any electrical circuit. The user should not plug the phone into a power outlet, and should not put a charged handset into the cradle, if the phone is located in an environment containing concentrations of flammable or flame-supporting gases, unless there is adequate ventilation. A spark in such an environment could create a fire or explosion. Such environments might include: medical use of oxygen without adequate ventilation; industrial gases (cleaning solvents; gasoline vapors; etc.); a leak of natural gas; etc.
15. Only put the handset of your telephone next to your ear when it is in normal talk mode.
16. The power adapters are intended to be correctly oriented in a vertical or floor mount position. The prongs are not designed to hold the plug in place if it is plugged into a ceiling, under-the-table or cabinet outlet.

## **SAVE THESE INSTRUCTIONS**

### **Battery**

- **CAUTION:** Use Only Supplied Battery.
- Do not dispose of the battery in a fire. Check with local waste management codes for special disposal instructions.

- Do not open or mutilate the battery. Released electrolyte is corrosive and may cause burns or injury to the eyes or skin. The electrolyte may be toxic if swallowed.
- Exercise care in handling batteries in order not to create a short circuit with conductive materials.
- Charge the battery provided with this product only in accordance with the instructions and limitations specified in this manual.

## Precautions for users of implanted cardiac pacemakers

Cardiac pacemakers (applies only to digital cordless telephones):

Wireless Technology Research, LLC (WTR), an independent research entity, led a multidisciplinary evaluation of the interference between portable wireless telephones and implanted cardiac pacemakers. Supported by the U.S. Food and Drug Administration, WTR recommends to physicians that:

### Pacemaker patients

- Should keep wireless telephones at least six inches from the pacemaker.
- Should NOT place wireless telephones directly over the pacemaker, such as in a breast pocket, when it is turned ON.
- Should use the wireless telephone at the ear opposite the pacemaker.

WTR's evaluation did not identify any risk to bystanders with pacemakers from other persons using wireless telephones.

### About cordless telephones

- **Privacy:** The same features that make a cordless telephone convenient create some limitations. Telephone calls are transmitted between the telephone base and the cordless handset by radio waves, so there is a

possibility that the cordless telephone conversations could be intercepted by radio receiving equipment within range of the cordless handset. For this reason, you should not think of cordless telephone conversations as being as private as those on corded telephones.

- **Electrical power:** The telephone base of this cordless telephone must be connected to a working electrical outlet. The electrical outlet should not be controlled by a wall switch. Calls cannot be made from the cordless handset if the telephone base is unplugged, switched off or if the electrical power is interrupted.
- **Potential TV interference:** Some cordless telephones operate at frequencies that may cause interference to televisions and VCRs. To minimize or prevent such interference, do not place the telephone base of the cordless telephone near or on top of a TV or VCR. If interference is experienced, moving the cordless telephone farther away from the TV or VCR often reduces or eliminates the interference.
- **Rechargeable batteries:** Exercise care in handling batteries in order not to create a short circuit with conducting material such as rings, bracelets and keys. The battery or conductor may overheat and cause harm. Observe proper polarity between the battery and the battery charger.
- **Nickel-metal hydride rechargeable batteries:** Dispose of these batteries in a safe manner. Do not burn or puncture the battery. Like other batteries of this type, if burned or punctured, they could release caustic material which could cause injury.

# Table of contents

## What's in the box? .....1

## Overview .....2

Telephone base overview .....	2
Charger overview .....	6
Display icons overview .....	6
Handset and Telephone base lights overview.....	7

## Connect .....8

Connect the telephone base.....	8
Connect the charger.....	8
Mount the telephone base.....	8
Install and charge the battery .....	9
Charge the battery.....	10
Before use .....	11

## Bluetooth.....12

Glossary of terms .....	13
Bluetooth setup.....	14
VTech Connect to Cell™ application ...	14
Add a Bluetooth enabled cell phone...	14
Add a Bluetooth enabled headset ....	16
Bluetooth connection from idle mode.....	17
Connect a paired cell phone or headset.....	17
Review the cell devices list .....	17
Download directory.....	17

## Configure your telephone .....19

Using the handset menu.....	19
Set language .....	19
Set date and time .....	19
Caller ID announce.....	19
Use caller ID to automatically set date and time .....	20
Home area code.....	21
Cell area code .....	21
Dial mode .....	22
QUIET mode.....	23
Temporary tone dialing .....	23

## Telephone Operations .....24

Make a home call .....	24
Predial a home call.....	24
Answer a home call .....	24
End a home call.....	24
Call waiting on the home line.....	25
Make a cell call .....	25
Predial a cell call.....	25
Answer a cell call.....	25
End a cell call .....	25
Call waiting on the cell line .....	25
Answer a cell call while on a home call.....	26
Answer a home call while on a cell call .....	26
Conference home and cell calls .....	26
Speakerphone .....	27
Volume control.....	27
Mute.....	27
Equalizer.....	27
Chain dialing.....	28
Temporary tone dialing .....	28
Hold .....	28
Find handset.....	29
Join a call in progress.....	29

## Intercom .....30

Initiate, answer, and end an intercom .....	30
Answer an incoming call during an intercom call .....	31
Call transfer using intercom .....	31

## Push-to-talk (PTT) .....33

Turn PTT on or off .....	33
PTT call to single device.....	33
PTT call to multiple devices.....	35
Answer a PTT call.....	36
Change a one-to-one PTT call to an intercom call .....	36
Answer an incoming call during a PTT call .....	37
Make an outgoing call during PTT call.....	37
End or leave a PTT call .....	38

**Redial.....38**

- Review a redial list entry.....38
- Dial a redial list entry.....38
- Delete a redial list entry.....38

**Directory.....39**

- Add a home directory entry.....39
- Review directory entries.....40
- Alphabetical search.....40
- Delete a phonebook entry.....41
- Edit a directory entry.....41
- Edit the type of a directory entry.....41
- Dial a directory entry.....42
- Remove a downloaded directory.....42

**Caller ID.....42**

- Review the caller ID log.....42
- Memory match.....43
- Missed call indicator.....43
- View dialing options.....43
- Dial a caller ID log entry.....44
- Save a caller ID log entry to  
the phonebook.....44
- Delete the caller ID log entries.....44

**Sound settings .....45**

- Key tone.....45
- Ringer tone.....45
- Handset ringer volume.....46
- Telephone base ringer volume.....46
- Temporary ringer silencing.....46

**About the built-in answering  
system and  
voicemail service .....47**

**Set your built-in  
answering system.....48**

- Turn the answering system on or off...48
- Default announcement.....48
- Record your own announcement.....48
- Play your announcement.....49
- Delete your announcement.....49
- Set number of rings.....49
- Turn the call screening on or off.....50
- Turn the message alert tone on  
or off.....50

**Using your built-in  
answering system.....51**

- New message indication.....51
- Message playback.....51
- Delete all messages.....52
- Record, play, and delete memos.....52
- Remote access.....53
- Set remote access code.....53
- Call screening.....54
- Call intercept.....54

**Using your built-in answering  
system and  
voicemail service .....55**

**Retrieve voicemail from  
telephone service.....55**

- Retrieve voicemail.....55
- Turn off then new  
voicemail indicators.....55
- Cell phone voicemail.....55

**Expand your telephone  
system .....56**

**Screen messages.....56**

**ECO mode.....60**

**General product care.....60**

**Frequently asked questions.....61**

**The RBRC® seal.....64**

**FCC, ACTA and IC  
regulations.....64**

**California Energy Commission  
battery charging testing  
instructions.....66**

**For C-UL compliance only.....67**

**Limited Warranty.....70**

**Technical Specifications.....72**

# What's in the box?

Your telephone package contains the following items. Save your sales receipt and original packaging in case it is necessary to ship your telephone for warranty service.

**NOTE**

To purchase replacement batteries or power adapters, visit our website at [www.vtechphones.com](http://www.vtechphones.com) or call **1 (800) 595-9511**. In Canada, go to [www.vtechcanada.com](http://www.vtechcanada.com) or dial **1 (800) 267-7377**.

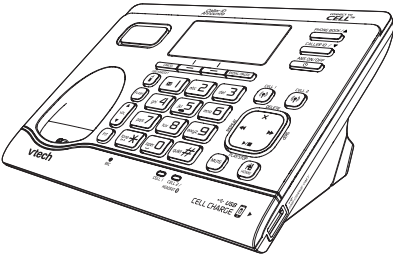

1 set for DS6291/DS6291-2/  
DS6291-3/DS6292-5

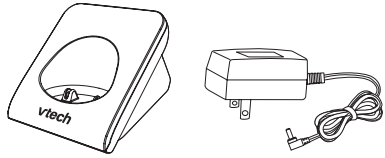

1 set for DS6291-2;  
2 sets for DS6291-3;  
4 sets for DS6291-5

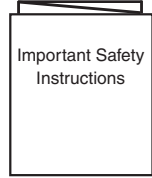

1 set for DS6291/DS6291-2/  
DS6291-3/DS6292-5

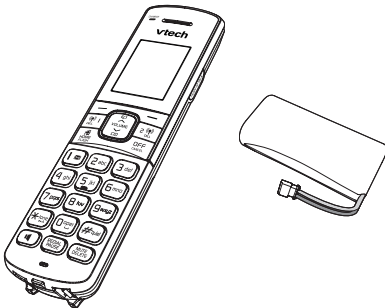

1 set for DS6291;  
2 sets for DS6291-2;  
3 sets for DS6291-3;  
5 sets for DS6292-5

# Overview

## Telephone base overview

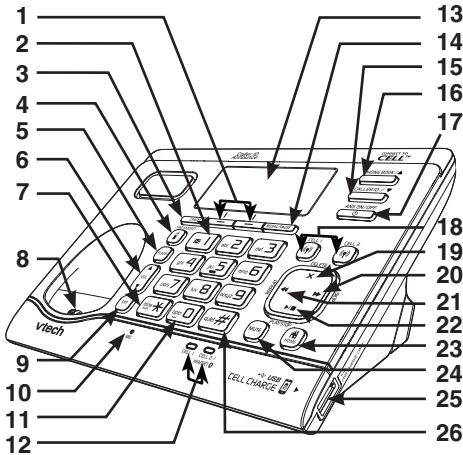

### 1 – Right Soft key

- Press to select the menu item displayed above the key.
- While in a menu, press to select an item; or save an entry or setting.

### Left Soft key

- Press to return to the previous menu.

### 2 – 1

- Press repeatedly to add or remove **1** in front of the caller ID log entry before dialing or saving it to the directory.
- Press and hold to set or dial your voicemail number.

### 3 – CANCEL

- Silence the ringer temporarily while the telephone base is ringing.

- Press and hold to erase the missed call indicator while the phone is not in use.
- Press to return to the previous menu; or press and hold to return to idle mode, without making changes.

### 4 – /FIND HANDSET

- Press to page all system handsets.

### 5 – FLASH

- Press to put the current home call on hold when there is an incoming call.
- Answer an incoming home call when you hear a call waiting alert.

### 6 – /VOL/

- Adjust the volume during a call or message playback.
- Adjust the telephone base ringer volume when the phone is not in use.

### 7 – Tone 0

- While you have set the dial mode to pulse and on a call, press to switch to tone dialing temporarily.

### 8 – Charging pole

### 9 – PTT (Push to talk)

- Press to display the PTT menu to begin a PTT call.
- Press and hold to begin a one-to-group PTT call.
- Press and hold while talking in a PTT call.

### 10 – MIC (Microphone)



## 11 – Oper

- Press to add a space when entering names.

## 12 – CELL 1 and CELL 2/HEADSET lights

- On when the telephone base is paired and connected with a Bluetooth device.
- Flash when the telephone base is in discoverable mode.

## 13 – LCD display

## 14 – REDIAL/PAUSE

- Press repeatedly to review the redial list.
- Press and hold to insert a dialing pause while entering a number.

## 15 – CALLER ID / ▼

- Review the caller ID log when the phone is not in use.
- Scroll down while in a menu, or in the directory, caller ID log, or redial list.
- Move the cursor to the left when entering numbers or names.

## 16 – PHONEBOOK / ▲

- Review the directory when the phone is not in use.
- Scroll up while in a menu, or in the directory, caller ID log, or redial list.
- Move the cursor to the right when entering numbers or names.

## 17 – /ANS ON/OFF

- Turn the answering system on or off.

## 18 – CELL 1 and CELL 2

- Make a cell call.
- Make or answer a home or cell call.

- Answer an incoming cell call when you hear a call waiting alert.

## 19 – X/DELETE

- Delete digits or characters while using dialing keys.
- Delete the playing message.
- Press twice to delete all previously reviewed messages when the phone is not in use.

## 20 – /REPEAT

- Press to repeat a message.
- Press twice to play the previous message.

## 21 – /SKIP

- Skip to the next message.

## 22 – /PLAY/STOP

- Play messages.
- Stop playing messages.

## 23 – /HOME

- Make a home call.
- Answer a home or cell call.
- Hang up a home call.

## 24 – MUTE

- Mute the microphone during a call.
- Silence the ringer temporarily while the telephone base is ringing.

## 25 – USB port

- Connect and charge your cell phones.

## 26 – quiet

- Press and hold to enter quiet mode.
- Press repeatedly to show other dialling options when reviewing a caller ID log entry.

# Handset overview

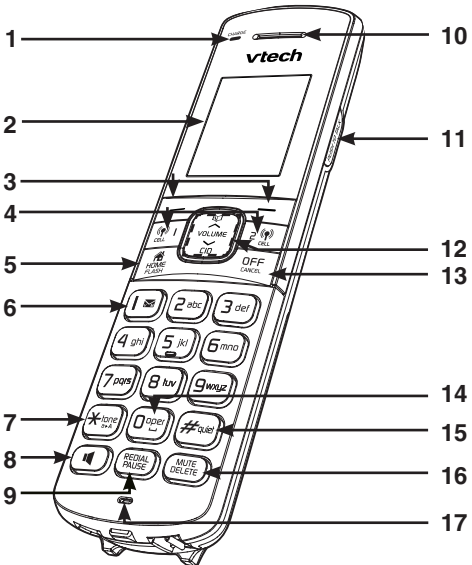

## 1 – CHARGE light

## 2 – LCD display

## 3 – Right Soft key

- Press to select the menu item displayed above the key.
- While in a menu, press to select an item; or save an entry or setting.

## Left Soft key

- Press to return to the previous menu.

## 4 – /CELL 1 and /CELL 2

- Make a cell call.
- Make or answer a home or cell call.
- Answer an incoming cell call when you hear a call waiting alert.

## 5 – /HOME/FLASH

- Make a home call.
- Make or answer a home or cell call.
- Press to put the current call on hold when there is an incoming call.
- Answer an incoming home call when you hear a call waiting alert.

## 6 – 1

- Press repeatedly to add or remove 1 in front of the caller ID log entry before dialing or saving it to the directory.
- Press and hold to set or dial your voicemail number.

## 7 – \*tone

- While you have set the dial mode to pulse and on a call, press to switch to tone dialing temporarily.

## 8 –

- Make or answer a call using the handset speakerphone.
- During a call, press to switch between the speakerphone and the handset.

## 9 – REDIAL/PAUSE

- Press repeatedly to review the redial list.
- Press and hold to insert a dialing pause while entering a number.

## 10 – Earpiece

## 11 – PUSH TO TALK

- Press to display the Push to talk (PTT) menu to begin a PTT call.
- Press and hold to begin a one-to-group PTT call.
- Press and hold while talking in a PTT call.

## 12 – VOLUME/↖/📞

- Review the directory when the phone is not in use.
- Increase the listening volume during a call or message playback.
- Scroll up while in a menu, or in the directory, caller ID log, or redial list.
- Move the cursor to the right when entering numbers or names.

## VOLUME/↘/CID

- Review the caller ID log when the phone is not in use.
- Decrease the listening volume during a call or message playback.
- Scroll down while in a menu, or in the directory, caller ID log, or redial list.
- Move the cursor to the left when entering numbers or names.

## 13 – OFF/CANCEL

- Hang up a call.
- Silence the ringer temporarily while the handset is ringing.
- Press and hold to erase the missed call indicator while the phone is not in use.
- Press to return to the previous menu, or press and hold to return to idle mode, without making changes.

## 14 – 0<sup>oper</sup>

- Press to add a space when entering names.

## 15 – #<sup>quiet</sup>

- Press and hold to enter quiet mode.
- Press repeatedly to show other dialing options when reviewing a caller ID log entry.

## 16 – MUTE/DELETE

- Mute the microphone during a call.
- Delete digits or characters while using the dialing keys.
- Delete the playing message on the handset.
- Silence the ringer temporarily while the handset is ringing.

## 17 – Microphone

## Charger overview

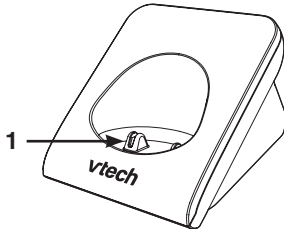









### 1 – Charging pole

## Display icons overview

### Handset icons

	<b>HOME line</b> - On steadily when the home line is in use or there is an incoming home call.
1 2	<b>CELL line</b> - On steadily when a cell line is in use or there is an incoming cell call.
1 2	<b>Bluetooth connected devices</b> - There are Bluetooth connected devices on the active devices list.
1 2	<b>Bluetooth disconnected devices</b> - There are Bluetooth disconnected devices on the active devices list.
2	<b>Wireless Bluetooth headset</b> - On steadily when a wireless Bluetooth headset is in use on the home line.
	<b>Battery status</b> - battery is charging (animated display).
	<b>Battery status</b> - the battery icon flashes when the battery is low and needs charging.
	<b>Speakerphone</b> - the speakerphone is in use.
	<b>Ringer off</b> - the handset ringer is off.
	<b>New voicemail</b> - you have new voicemail from your telephone service provider.
<b>ANS ON</b>	<b>Answering system on</b> - the answering system is turned on to answer calls.
	<b>Message</b> - new message in the built-in answering system.
<b>ECO</b>	<b>ECO mode</b> - activates automatically to reduce power consumption when the handset is within range from the telephone base.
<b>NEW</b>	<b>New caller ID log</b> - new and missed calls.
<b>MUTE</b>	<b>MUTE</b> - the handset microphone is off.

## Telephone base icons





	<b>HOME</b> line - On steadily when the home line is in use or there is an incoming home call.
 1  2	<b>CELL</b> line - On steadily when a cell line is in use or there is an incoming cell call.
 1 2	<b>Bluetooth connected devices</b> - There are Bluetooth connected devices on the active devices list.
 1 2	<b>Bluetooth disconnected devices</b> - There are Bluetooth disconnected devices on the active devices list.
 2	<b>Wireless Bluetooth headset</b> - On steadily when a wireless Bluetooth headset is in use on the home line.
	<b>Ringer off</b> - the handset ringer is off.
	<b>New voicemail</b> - you have new voicemail from your telephone service provider.
<b>ANS ON</b>	<b>Answering system on</b> - the answering system is turned on to answer calls.
	<b>Message</b> - new message in the built-in answering system.
<b>ECO</b>	<b>ECO mode</b> - activates automatically to reduce power consumption when the handset is within range from the telephone base.
<b>NEW</b>	<b>New caller ID log</b> - new and missed calls.
<b>MUTE</b>	<b>MUTE</b> - the telephone base microphone is off.

## Handset and Telephone base lights overview

### Handset lights

	On when the handset speakerphone is in use.
<b>CHARGE</b>	On when the handset is charging in the telephone base or handset charger.

### Telephone base lights

 /HOME	On when the telephone line is in use. On when the answering system is answering a call. On when you are registering a handset. Flashes quickly when there is an incoming call. Flashes when another telephone sharing the same line is in use. Flashes when you are deregistering all handsets.
 CELL 1/  CELL 2	On when the cell line is in use. Flashes quickly when there is an incoming cell call. Flashes slowly when the cell call is on hold.
 /ANS ON/OFF	On when the answering system is turned on.

## Connect

You can choose to connect the telephone base for desktop usage or wall mounting.

### NOTES

- Use only the adapters provided.
- Even if you do not subscribe to any conventional telephone service, you can pair a Bluetooth enabled cell phone to your telephone base (see Bluetooth), and use the cell line alone without plugging in a telephone line cord.
- Make sure the electrical outlets are not controlled by wall switches.
- The adapters are intended to be correctly oriented in a vertical or floor mount position. The prongs are not designed to hold the plug in place if it is plugged into a ceiling, under-the-table or cabinet outlet.

### TIP

- If you subscribe to digital subscriber line (DSL) high-speed Internet service through your telephone line, make sure you install a **DSL filter** (not included) between the telephone line cord and telephone wall jack. Contact your DSL service provider for more information.

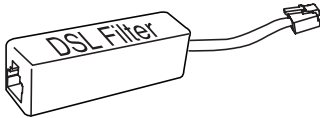

## Connect the telephone base

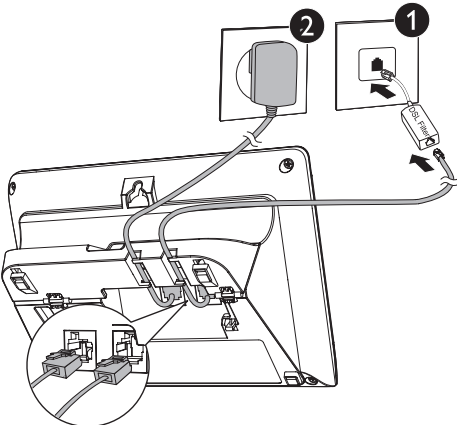

## Connect the charger

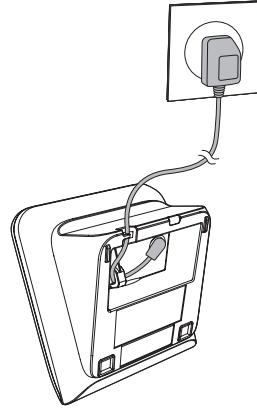

## Mount the telephone base

The telephone comes ready for tabletop use. If you have already installed the telephone for tabletop use, unplug the telephone line cord from the telephone wall jack, and unplug the telephone base power adapter from the wall outlet before mounting your telephone on a wall. Follow the steps below to mount your telephone on a wall.

1. Press down on the tabs on the wall mount bracket on the telephone base to release it from tabletop orientation.

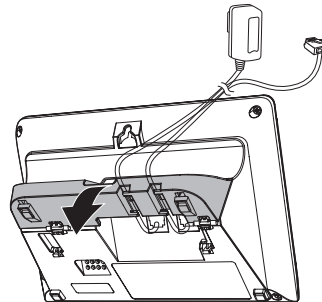

- 2 Rotate the wall mount bracket down to wall mount position and then push it into the telephone base until it clicks into place.

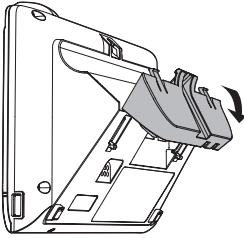

3. Plug the telephone line cord (or DSL filter) into the wall jack. Align the holes on the back of the telephone base with the standard wall plate. Slide the bracket down until it clicks securely in place. Connect the power adapter to the telephone base and an electrical outlet not controlled by a wall switch.

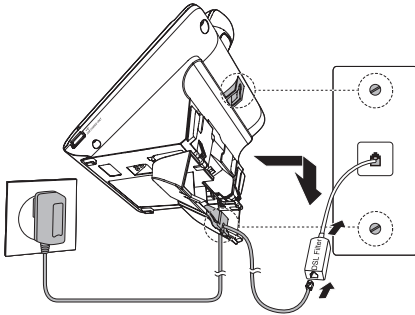

4. Connect the power adapter to the telephone base and an electrical outlet not controlled by a wall switch.

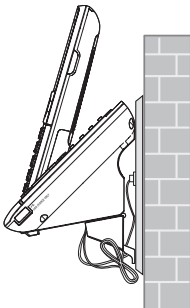

## Install and charge the battery

Install the battery as shown below.

### NOTES

- Use only supplied battery.
- If the handset will not be used for a long time, disconnect and remove the battery to prevent possible leakage.

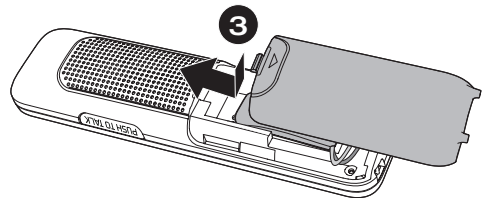
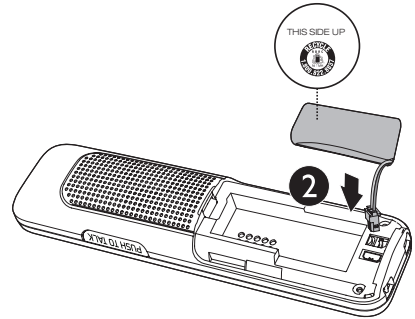
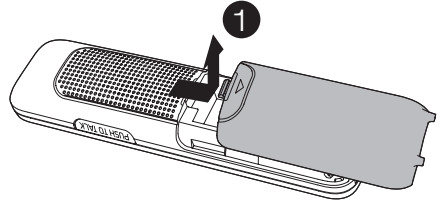

## Charge the battery

Place the handset in the telephone base or the charger to charge.

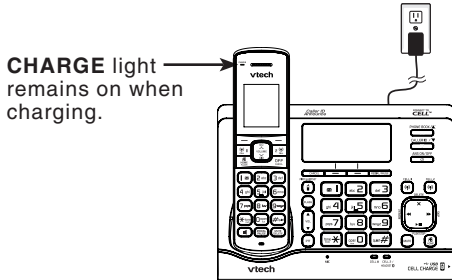

Once you have installed the battery, the handset LCD display indicates the battery status (see the table below).

### NOTES

- For best performance, keep the handset in the telephone base or charger when not in use.
- The battery is fully charged after 12 hours of continuous charging.
- If you place the handset in the telephone base or the charger without plugging in the battery, the screen displays **No battery**.

Battery indicators	Battery status	Action
The screen is blank, or displays <b>Place in charger</b> and ⇨ flashes.	The battery has no or very little charge. The handset cannot be used.	Charge without interruption (about 30 minutes).
The screen displays <b>Low battery</b> and ⇨ flashes.	The battery has enough charge to be used for a short time.	Charge without interruption (about 30 minutes).
The screen displays <b>HANDSET X</b> .	The battery is charged.	To keep the battery charged, place it in the telephone base or handset charger when not in use.

When it is fully charged, you can expect the following performance:

Operation	Operating time
While in handset use (talking*)	Seven hours
While in speakerphone mode (talking*)	Three hours
While not in use (standby**)	Seven days

\* Operating times vary depending on your actual use and the age of the battery.

\*\* Handset is not charging or in use.



## Before use

After you install your telephone or power returns following a power outage, the handset will prompt you to set the date and time.

If you choose to set up the date and time at a later stage, you can do it manually.

## Set date and time

### NOTE

- Make sure you set the date and time including the year correctly; otherwise the answering system does not announce the correct day of the week for your recorded messages time stamp.
1. Use the dialing keys **(0-9)** to enter the month, date, and year, and then press **NEXT**.
  2. Use the dialing keys **(0-9)** to enter the hour and minute.
  3. Scroll to choose **AM** or **PM**, and then press **SAVE** to save.

## Check for a dial tone:

Press **\*/HOME**. If you hear a dial tone, the installation is successful.

### If you do not hear a dial tone:

- Make sure the installation procedures described above are properly done.
- It may be a wiring problem. If you have changed your telephone service to digital service from a cable company or a VoIP service provider, the telephone line may need to be rewired to allow all existing telephone jacks to work. Contact your cable/VoIP service provider for more information.

## Operating range

This cordless telephone operates with the maximum power allowed by the Federal Communications Commission (FCC). Even so, this handset and telephone base can communicate over only a certain distance - which can vary with the locations of the telephone base and handset, the weather, and the layout of your home or office.

When the handset is out of range, the handset displays **Out of range OR no power at base** and **Put HS on base to power base** alternately.

If there is a call while the handset is out of range, it may not ring, or if it does ring, the call may not connect well when you press **\*/HOME**, **\*/CELL 1**, or **\*/CELL 2**. Move closer to the telephone base, and then press **\*/HOME** or **\*/CELL 1**, or **\*/CELL 2** to answer the call. If the handset moves out of range during a telephone conversation, there may be interference. To improve reception, move closer to the telephone base.

# Bluetooth

Your new **DS6291/DS6292** telephone system with Bluetooth wireless technology has the following features:

- Pair and connect up to a maximum of two cell phones with the telephone base to make and receive cell calls. Only one cell phone can be active on a call at a time.
- Make and receive calls using your cell phone plan while utilizing the ease and comfort of your home telephone system.
- Receive phonebook entries from your cell phone.

## IMPORTANT INFORMATION

- Refer to the user's manual of your Bluetooth enabled cell phone for more information about how that device uses Bluetooth connectivity.
- Bluetooth wireless technology operates within a short range (a maximum of approximately 30 feet) from the telephone base. Keep connected cell phones within this range. For optimal performance, keep your cell phone within 15 feet of the telephone base while using the **DS6291/DS6292** cell line.

- If your cell phone has poor reception in your home, the **DS6291/DS6292** cannot improve the reception. However, if there is a location in your house with better reception, you can leave your cell phone at that location while using the **DS6291/DS6292** cell line.
- If you experience poor sound quality, place your cell phone closer to the **DS6291/DS6292** to ensure strong Bluetooth signal strength. Make sure there are no physical obstacles between the **DS6291/DS6292** and the cell phone, such as large furniture or thick walls.
- Charge your cell phone while it is connected to the telephone base. Your cell phone's battery will discharge faster while it is connected to the telephone base via Bluetooth wireless technology.
- Monitor your cell phone's usage because minutes are deducted from your cellular plan for the duration of all cell calls.

Refer to **Bluetooth setup** to learn how to set up and manage your Bluetooth enabled devices. Refer to **Telephone operation** on how to operate your Bluetooth devices with your new **DS6291/DS6292** telephone system with Bluetooth wireless technology. Refer to **Troubleshooting** if you experience difficulty using the telephone system.

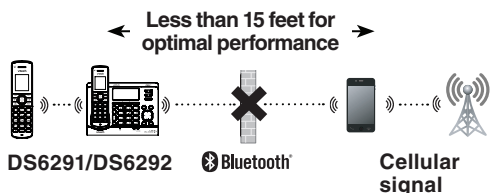

The *Bluetooth*® word mark and logos are owned by Bluetooth SIG, Inc. and any use of such marks by VTech Holdings Limited is under license. VTech Holdings Limited is a member of Bluetooth SIG, Inc. Other trademarks and trade names are those of their respective owners.

## Glossary of terms

Below are some terms used in this user's manual to help you become familiar with using your Bluetooth enabled cell phone and your new **DS6291/DS6292** telephone system.

**Bluetooth cell phone** - refers to a Bluetooth enabled cellular telephone.

**Cell line** - the telephone line associated with your cell phone service. On your **DS6291/DS6292** handset, press **☎/CELL** to use the cell line.

**Connected** - when you pair a Bluetooth cell phone to the **DS6291/DS6292**, it is automatically connected. When a cell phone is connected, **1** and/or **2** displays after **☎** on the handset and the **☎ CELL 1** and/or **☎ CELL 2/HEADSET** light on the telephone base is on. If a cell phone loses its connection to the telephone base, it must be reconnected before you can use the cell phone with the **DS6291/DS6292**.

**Disconnected** - when a cell phone is disconnected, the **☎** on the handset no longer displays and the **☎ CELL 1** and/or **☎ CELL 2/HEADSET** light on the telephone base is off.

**Discoverable mode** - before a Bluetooth enabled device can be paired, it must be set to this mode. When pairing your cell phone, the telephone base will be set to this mode. Depending on the manufacturer, this mode is sometimes referred to as **Find Me** or **Visibility**.

**Home line** - your conventional telephone land line. On your **DS6291/DS6292** handset, press **🏠/HOME/FLASH** to use the home line.

**Paired device** - once a Bluetooth enabled cell phone has been paired with the telephone base, it appears on the cell devices list. A maximum of two cell phones can be paired with the telephone base.

**Pairing** - this refers to the process of Bluetooth enabled cell phone registering device information with each other. The telephone base must be paired with the Bluetooth enabled cell phone before it can be used. Depending on the manufacturer, this is also referred to as **Bonding**.

**PIN** - by default, the PIN is **0000** for the telephone base and for most Bluetooth devices. PIN information must be exchanged between Bluetooth devices before they can be used. This is also known as a **Passkey** or **Passcode**.

## Bluetooth setup

To use a Bluetooth enabled cell phone with your **DS6291/DS6292**, you must first pair and connect it with the telephone base. All **DS6291/DS6292** handsets can be used to make or answer on the cell phone line.

Bluetooth wireless technology operates within a short range (30 feet). When you pair a Bluetooth cell phone to the telephone base, move closer to the telephone base to maintain sufficient signal strength. For optimal performance, keep your cell phone within 15 feet of the telephone base while using the cell line.

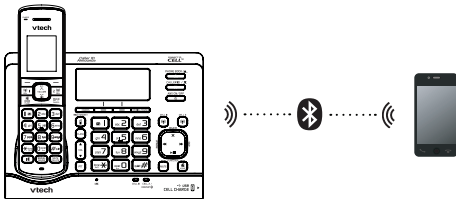

## VTech Connect to Cell™ application

If you are using Bluetooth enabled Android® phones (OS 2.3 or higher), you can further extend the flexibility of your telephone system with use of this free application.

**VTech Connect to Cell** comprises **Caller ID manager** and **Alerts manager** that help you integrate your cell phone with your new **DS6291/DS6292**.

To learn more or download this application via **Google Play® Store**, Scan the QR code on the right, or go to

[http://www.vtechphones.com/app\\_connect\\_to\\_cell](http://www.vtechphones.com/app_connect_to_cell).



Android® and Google Play® are registered trademarks of Google Inc.

## Add a Bluetooth enabled cell phone

Before you begin, make sure that you have cellular coverage and your Bluetooth enabled cell phone is not connected to any other Bluetooth devices. Refer to your cell phone user's manual to learn how to search for or add new Bluetooth devices.

All paired cell phones are shown on the cell devices list.

Once you have paired and connected a device with the telephone base, you do not need to repeat the procedure again unless you want to replace the existing paired cell phone with a new one.

### To pair and connect a cell phone:

1. Press **MENU** on the telephone base in idle mode to enter the main menu.
2. Press **CALLER ID/▼** or **PHONEBOOK/▲** to highlight **Bluetooth**, and then press **SELECT**.
3. Press **SELECT** to choose **Add device**.
4. Press **SELECT** to choose **Add cellular**. The screen displays **Please wait...** followed by **1. If cell is connected to BT device, please disconnect it.**
  - If there are already 4 paired devices on the device list, the 4th device will be automatically removed, regardless of whether the new device pairing is successful or not.
  - If there are already 2 active devices on the device list with prefix **D1:** or **D2:**, the telephone base shows **Cell Phone A is deactivated for adding a new device.**

5. Press **NEXT**. The screen displays  
**2. Place cell phone next to base.**

- All devices that are connected to the telephone base are disconnected until the pairing process is completed.

6. Press **NEXT** to turn on the telephone base discoverable mode. The screen displays **Set cell to search base: VTech DS6291 PIN: 0000**. Promptly turn on the Bluetooth feature of your cell phone and search for or add new devices.

7. Once your cell phone finds your VTech phone (**VTech DS6291**), press the appropriate key on your cell phone to continue the pairing process.

- Your cell phone may require a passcode. In this case, the telephone base displays **Check cellular. ENTER PASS CODE**. Enter the cell phone passcode (typically **0000**) into the telephone base and press **SET**.
- Enter the PIN of the telephone base (the default PIN is **0000**) into your cell phone to continue the pairing process if required. The telephone base displays **Adding Cell Phone A**.

8. When a device is successfully connected, the telephone base displays **Cell Phone A is added and connected to base** and the corresponding status icon (📶<sub>1</sub> or 📶<sub>2</sub>) displays. The corresponding device light on the telephone base (**CELL 1** or **CELL 2/HEADSET**) turns on.

When the cell phone is successfully paired and connected to the telephone base, the corresponding status icon (📶<sub>1</sub> or 📶<sub>2</sub>) displays. The corresponding device light (📶 **CELL 1** and/or 📶 **CELL 2/HEADSET**) turns on.

#### NOTES



- The pairing process may take up to one minute. If the pairing process fails, turn off the Bluetooth feature on your cell phone and on the **DS6291/DS6292** by pressing 📶 **CELL 1**/ 📶 **CELL 2/HEADSET**. Then repeat the steps above to pair and connect again. In some cases, it may take you a few attempts to complete the pairing process.
- The steps for the pairing process may vary for different cell phones. If this happens, follow the prompts on your cell phone and your **DS6291/DS6292** to complete the pairing process.

**If you have trouble pairing your cell phone, it may not be compatible with your DS6291/DS6292. Check the Bluetooth compatibility list at [www.vtechphones.com](http://www.vtechphones.com).**

## Add a Bluetooth enabled headset

### To pair and connect a headset:

1. Press **MENU** on the telephone base in idle mode to enter the main menu.
2. Press **CALLER ID/▼** or **PHONEBOOK/▲** to highlight **Bluetooth**, and then press **SELECT**.
3. Press **SELECT** to choose **Add device**.
4. Press **CALLER ID/▼** or **PHONEBOOK/▲** to highlight **Add headset**, and then press **SELECT**. The screen displays **If headset is connected to cell, please disconnect it**.
  - If there are already 4 paired devices on the device list, the 4th device will be automatically removed, regardless of whether the new device pairing is successful or not.
  - If there is another headset already active, the screen will show **Only the BT headset in slot 2 can be ready for connection, and then Headset X is deactivated for adding a new device**.
5. Press **NEXT**. The screen displays **PLS set headset to discoverable mode**. Set your headset to discoverable mode (refer to the user's manual of your headset), and then press **NEXT**.
6. The screen displays **Searching for Bluetooth headsets...**
7. When the screen displays the found devices, press **CALLER ID/▼** or **PHONEBOOK/▲** to highlight your headset if necessary, and then press **SELECT**.

- Enter the PIN of your headset if required. The PIN for most Bluetooth devices is **0000** (refer to the user's manual of your headset), and then press **NEXT**.
8. The screen displays **Adding Headset A** when the base is connecting to your headset.
  9. When a device is successfully connected, the telephone base displays **Headset A is added and connected to base** and the corresponding status icon . You hear a confirmation tone. The corresponding light on the telephone base **CELL 2/HEADSET**  turns on.

### NOTES

- The pairing process may take up to one minute. If the pairing process fails, try again.
- When a connected headset is charging, it may disconnect from the telephone base and the **CELL 2/HEADSET**  light on the telephone base turns off. For some headset models, you may need to turn on the headset and reconnect it to the telephone base again.

**If you have trouble pairing your headset, it may not be compatible with your DS6291/DS6292. Check the Bluetooth compatibility list at [www.vtechphones.com](http://www.vtechphones.com).**

## Bluetooth connection from idle mode

When you have active devices that are not connected, **CONNECT** appears on the telephone base in idle mode. Press **CONNECT** to start connecting an active device. When there are two active devices, the screen will prompt you to choose one before connection.

## Connect a paired cell phone or headset

If you need to connect your paired cell phone or headset to the telephone base manually:

1. Press **CELL 1** and/or **CELL 2/HEADSET** on the telephone base when it is not in use. The **CELL 1** and/or **CELL 2/HEADSET** light flashes.
2. When the cell phone or headset is connected to the telephone base, you hear two beeps. The corresponding status icon (**1** or **2**) displays. The corresponding device light (**CELL 1** and/or **CELL 2/HEADSET**) turns on.

## Review the cell devices list

1. Press **MENU** on the handset when it is not in use.
  2. Press **CALLER ID/▼** or **PHONEBOOK/▲** to highlight **Bluetooth**, and then press **SELECT**.
  3. Press **CALLER ID/▼** or **PHONEBOOK/▲** to highlight **Device list**, and then press **SELECT**.
- **Phone memory** - download all contacts stored in your phone memory.
  - **SIM card only** - download all contacts stored in your SIM card.
  - **Phone and SIM** - download all contacts stored in both your phone memory and SIM card.

## Download directory

You can download directory entries to your **DS6291/DS6292** telephone system via Bluetooth wireless technology. Each downloaded directory are stored in the handset directory with up to 24 digits for each phone number and 15 characters for each name.

Before downloading the directory, make sure the cell phone is paired and connected to the **DS6291/DS6292**. Make sure the handset battery is charged for at least 10 minutes.

**Place your cell phone next to the telephone base while downloading.**

## To download a cell phone directory:

1. Press **MENU** on the telephone base in idle mode.
  2. Press **CALLER ID/▼** or **PHONEBOOK/▲** to highlight **Bluetooth**, and then press **SELECT**.
  3. Press **CALLER ID/▼** or **PHONEBOOK/▲** to highlight **Download dir**, and then press **SELECT**.
  4. Press **CALLER ID/▼** or **PHONEBOOK/▲** to highlight a device, and then press **SELECT**.
  5. Press **CALLER ID/▼** or **PHONEBOOK/▲** to highlight one of the following options:
    - **Phone memory** - download all contacts stored in your phone memory.
    - **SIM card only** - download all contacts stored in your SIM card.
    - **Phone and SIM** - download all contacts stored in both your phone memory and SIM card.
- Press **SELECT**. During the download, the telephone base displays the progress. All handsets display **Downloading...**

- Your cell phone may require a passcode. In this case the screen displays **Check cellular. ENTER PASSCODE**. Enter the cell phone passcode into the telephone base and press **SET** to save.
- Your cell phone may require you to press a key to confirm the directory download.
- If the selected device's directory has already been downloaded to your telephone system before, the telephone base displays the last update date of your cell phone. The directory stored on your telephone system for that cell phone will be erased and replaced with the current cell phone directory. If you have edited the downloaded entries, those changes will be lost. Press **NEXT** to start the download.
- If you already have 4 downloaded directories, the telephone base displays **Memory is full. Replace existing directory?** Press **YES**. Highlight the cell phone directory to be replaced and press **SELECT**. The screen displays **Replace Cell Phone A directory?** Press **YES** to confirm.

6. When the downloading process is complete, the telephone base displays **Download ended XXXX entries saved**. Press **OK** to return to the **Bluetooth** menu.

#### NOTES

- With certain cell phones, downloading from the SIM card is not supported. If this is the case, try transferring the contacts from your SIM card to your cell phone memory first, and then download from your cell phone memory. For more information on how to transfer contacts from your SIM

card to your cell phone memory, see your cell phone's user's manual.

- If **Phone memory** is chosen but with no entries saved, the telephone base displays **No entries found. Download from SIM only?** Press **YES** to confirm. If **SIM card only** is chosen but with no entries saved, the telephone base displays **No entries found. Download from Phone only?** Press **YES** to confirm. If **Phone and SIM** are chosen but with no entries saved in either or both directories, the telephone base displays **No entries found. Download from Phone only?** Press **YES** to confirm.
- When downloading the directory from your Bluetooth enabled cell phone, some data may not transfer. For example, if you have home, mobile and work numbers for a particular contact, the three category descriptions may not transfer to your **DS6291/DS6292**.
- For Android and Blackberry cell phones, you may also download your cell phone directory to your **DS6291/DS6292** via the VTech Contact Share application. Scan the QR code on the right, or go to [www.vtechphones.com/apps/contact\\_share](http://www.vtechphones.com/apps/contact_share) for application download.





# Configure your telephone

## Using the handset menu

1. Press **MENU** when the phone is not in use.
2. Press  $\vee$  or  $\wedge$  on the handset or **CALLER ID/  $\blacktriangledown$**  or **PHONEBOOK/  $\blacktriangle$**  on the telephone base to scroll until the screen displays the desired feature menu.
3. Press **SELECT** to enter that menu.
  - To return to the previous menu, press **CANCEL** on the handset.
  - To return to idle mode, press and hold **CANCEL** on the handset.

## Set language

You can select a language (**English**, **French** or **Spanish**) to be used in all screen displays.

1. Press **MENU** in idle mode to enter the main menu.
2. Press  $\vee$  or  $\wedge$  on the handset, or **CALLER ID/  $\blacktriangledown$**  or **PHONEBOOK/  $\blacktriangle$**  on the telephone base to scroll to **Settings**, then press **SELECT**.
3. Press **SELECT** to choose **LCD language**.
4. Press  $\vee$  or  $\wedge$  on the handset, or **CALLER ID/  $\blacktriangledown$**  or **PHONEBOOK/  $\blacktriangle$**  on the telephone base to highlight **English**, **Français** or **Español**, then press **SELECT**. The screen prompts **Set English/Français/Español as LCD language?**
5. Press **YES** to save your preference. There is a confirmation tone and the screen returns to the previous menu. Press **NO** to cancel the operation.



If you accidentally changed the LCD language to French or Spanish, you can reset it to English easily by pressing **MENU** and then entering <sup>TOUCH</sup>**\*364#**.

## Set date and time



- Make sure you set the date and time including the year correctly; otherwise the answering system does not announce the correct day of the week for your recorded messages time stamp.
1. Press **MENU** on the handset or telephone base when idle.
  2. Press  $\vee$  or  $\wedge$  on the handset, or **CALLER ID/  $\blacktriangledown$**  or **PHONEBOOK/  $\blacktriangle$**  on the telephone base to scroll to **Set date/time**, and then press **SELECT**.
  3. Use the dialing keys (**0-9**) to enter the month, date, and year, and then press **NEXT**.
  4. Use the dialing keys (**0-9**) to enter the hour and minute.
  5. Press  $\vee$  or  $\wedge$  on the handset, or **CALLER ID/  $\blacktriangledown$**  or **PHONEBOOK/  $\blacktriangle$**  on the telephone base to scroll to choose **AM** or **PM**, and then press **SAVE** to save.

## Caller ID announce

The caller ID announce feature lets you know who's calling without having to look at the display. When you have an incoming call, the handset and/or base speaks "Call from..." and the name of the caller based on the directory or caller ID information. If the caller's name is private or unknown, the phone number up to the last 11 digits will be announced. If the caller's phone number is also private or unknown, no information will be announced. The default setting is **On**.

### To turn on or off the caller ID announce feature:

1. Press **MENU** in idle mode to enter the main menu.
2. Press  $\downarrow$  or  $\uparrow$  on the handset, or **CALLER ID/  $\blacktriangledown$**  or **PHONEBOOK/  $\blacktriangle$**  on the telephone base to scroll to **Caller ID annnc**, then press **SELECT**.
3. Press  $\downarrow$  or  $\uparrow$  on the handset, or **CALLER ID/  $\blacktriangledown$**  or **PHONEBOOK/  $\blacktriangle$**  on the telephone base to highlight **On** or **Off**, then press **SELECT**. There is a confirmation tone. The handset and telephone base screen show **CID Annnc ON/OFF on all HS & BS** briefly before returning to the previous menu.

### NOTES

- To use the caller ID announce feature, you must subscribe to caller ID service from your telephone service provider.
- When there are up to five handsets registered, the telephone system supports caller ID announce for all handsets. If six or more handsets are registered, the system supports caller ID announce for the first four registered handsets only.
- This feature does not announce information for call waiting calls.
- It takes at least 2 rings for the phone to receive caller ID information and announce

it. If the phone is answered before the end of the second ring, the phone won't have time to announce the caller's information.

- Pronunciation of names may vary with this feature. Not all names may be pronounced correctly.
- When this feature is on, the telephone plays both the caller ID information and the ringer at the same time when there is an incoming call.
- Caller ID announce is available in English only.

## Use caller ID to automatically set date and time

If you subscribe to caller ID service, the day, month and time are set automatically with each incoming call. Follow the steps below to turn the **CID time sync** feature on or off. The default setting is **On**.

1. Press **MENU** in idle mode to enter the main menu.
2. Press  $\downarrow$  or  $\uparrow$  on the handset, or **CALLER ID/  $\blacktriangledown$**  or **PHONEBOOK/  $\blacktriangle$**  on the telephone base to scroll to **Settings**, then press **SELECT**.
3. Press  $\downarrow$  or  $\uparrow$  on the handset, or **CALLER ID/  $\blacktriangledown$**  or **PHONEBOOK/  $\blacktriangle$**  on the telephone base to scroll to **CID time sync**, then press **SELECT**.
4. Press  $\downarrow$  or  $\uparrow$  on the handset, or **CALLER ID/  $\blacktriangledown$**  or **PHONEBOOK/  $\blacktriangle$**  on the telephone base to highlight **On** or **Off**, then press **SELECT** to save. There is a confirmation tone and the screen returns to the previous menu.

## Home area code

If you dial your local calls using only seven digits (area code not required), you can program your home area code so that when you receive a call within your local area, the telephone number is automatically stored without the area code in the caller ID log.

1. Press **MENU** in idle mode to enter the main menu.
2. Press  $\vee$  or  $\wedge$  on the handset, or **CALLER ID/  $\blacktriangledown$**  or **PHONEBOOK/  $\blacktriangle$**  on the telephone base to scroll to **Directory**, then press **SELECT**.
3. Press **OPTION** to choose **Home**.
4. Press  $\vee$  or  $\wedge$  on the handset to scroll to **Home areacode**, then press **SELECT**. The screen briefly shows **Only for 7 digit dial from CID**.

-OR-

Press **CALLER ID/  $\blacktriangledown$**  or **PHONEBOOK/  $\blacktriangle$**  on the telephone base to scroll to **Home area code**, then press **SELECT**.

The screen briefly shows **Only for 7 digits dialing from Caller ID log**.

5. Use the dialing keys to enter a three-digit home area code.
  - Press **MUTE/DELETE** on the handset, or **X/DELETE** on the telephone base to erase a digit.
  - Press and hold **MUTE/DELETE** on the handset, or **X/DELETE** on the telephone base to erase all digits.
6. Press **SAVE** to confirm. There is a confirmation tone. The handset screen shows **Areacode will not show in CID** and the telephone base screen shows **Area code will not show in Caller ID log** briefly before returning to the previous menu.

## NOTE

If, in the future, your telephone service provider requires you to dial the area code when making a local call, or, if you move to a location that requires it, delete the home area code you have already programmed, following the steps above. After you have deleted the home area code, **\_ \_ \_** will appear on the display.

## Cell area code

Most cell phone entries are stored in a 10-digit format. If all of your cell phone entries are stored this way, you do not need to program your cell area code.

If your cell phone stores entries in a 7-digit format, we recommend that you program your cell area code so that your 7-digit directory entries can be dialed correctly using your home line.

### To set the cell area code:

1. Press **MENU** on the handset in idle mode to enter the main menu.
2. Press  $\vee$  or  $\wedge$  on the handset, or **CALLER ID/  $\blacktriangledown$**  or **PHONEBOOK/  $\blacktriangle$**  on the telephone base to highlight **Directory**, then press **SELECT**.
3. Press  $\vee$  or  $\wedge$  on the handset, or **CALLER ID/  $\blacktriangledown$**  or **PHONEBOOK/  $\blacktriangle$**  on the telephone base to highlight the desired downloaded directory, then press **OPTION**.
4. Press  $\vee$  or  $\wedge$  on the handset to scroll to **Cell areacode**, then press **SELECT**. The screen briefly shows **Only for 7 digit dial from CID**.

-OR-

Press **CALLER ID/  $\blacktriangledown$**  or **PHONEBOOK/  $\blacktriangle$**  on the telephone base to scroll to **Cell area code**, then press **SELECT**. The screen briefly shows **Only for 7 digits dialing from Caller ID log**.

5. Use the dialing keys to enter the desired cell area code.
  - Press **DELETE** on the handset, or **X/DELETE** on the telephone base to erase a digit.
  - Press and hold **DELETE** on the handset, or **X/DELETE** on the telephone base to erase all digits.
6. Press **SAVE** to confirm. There is a confirmation tone. The handset screen shows **Areacode will not show in CID** and the telephone base screen shows **Area code will not show in Caller ID log** briefly before returning to the previous menu.

## Dial mode

The dial mode is preset to touch-tone dialing. If you have pulse (rotary) service, you must change the dial mode to pulse dialing before using the telephone to make a call.

1. Press **MENU** in idle mode to enter the main menu.
2. Press **▼** or **▲** on the handset, or **CALLER ID/▼** or **PHONEBOOK/▲** on the telephone base to scroll to **Settings**, then press **SELECT**.
3. Press **▼** or **▲** on the handset, or **CALLER ID/▼** or **PHONEBOOK/▲** on the telephone base to scroll to **Dial mode**, then press **SELECT**.
4. Press **▼** or **▲** on the handset, or **CALLER ID/▼** or **PHONEBOOK/▲** on the telephone base to highlight **Touch-tone** or **Pulse**, then press **SELECT**. There is a confirmation tone and the screen returns to the previous menu.

## QUIET mode

When **QUIET** mode is turned on, the telephone silences all sounds during the set period of time (1-12 hours). However, the handset locator paging tone and any sound-generating operations initiated by users, such as making calls using the speakerphone or setting ringer volume, will sound as normal. After you turn on **QUIET** mode, this feature activates immediately and the answering system turns on automatically.

When **QUIET** mode is on, the answering system takes calls and records messages without broadcasting them.

### To turn QUIET mode on:

1. Press and hold QUIET # in idle mode to enter the **QUIET** mode setting screen. The screen shows **Set quiet mode duration (1 to 12 hours) \_ \_**.
2. Use the dialing keys to enter the desired number of hours (1-12) you would like to turn on **QUIET** mode, then press **SELECT**. Your screen briefly shows **Answering sys is ON during quiet mode** and then **Quiet mode on** in the idle screen.

### To turn QUIET mode off:

- While **QUIET** mode is on, press and hold QUIET #. The screen then shows **Quiet mode is off** and you hear a confirmation tone.

### NOTES

- If you change the base ringer, handset ringer, ringer volume, key tone, or caller ID announce features when **QUIET** mode is on, the sample plays but the feature is still muted after saving the setting.
- After **QUIET** mode is turned off or the set period of time has expired, all muted features will be activated again.
- The **PTT** function is not available when **QUIET** mode is on.

## Temporary tone dialing

If you have pulse (rotary) service only, you can switch from pulse to touch-tone dialing temporarily during a call. This is useful if you need to send touch-tone signals to access your telephone banking or long distance services.

1. During a call, press **\*tone**.
2. Use the dialing keys to enter the number you wish to dial.
3. The telephone sends touch-tone signals. The telephone automatically returns to pulse dialing mode after you end the call.

# Telephone Operations

Handset control key panel:

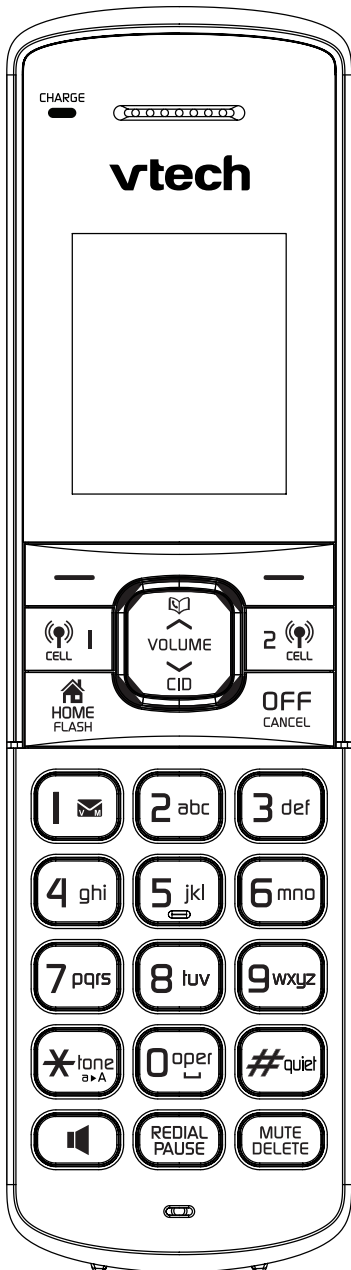

## Make a home call

1. Press **🏠/HOME** or **📞** on the handset or telephone base.
2. When you hear a dial tone, dial the number.

### 📞NOTES

- The handset or telephone base shows the elapsed time as you talk (in hours, minutes and seconds).
- While entering numbers, press and hold PAUSE to insert a dialing pause (a **p** appears).

## Predial a home call

1. Enter the telephone number.
2. Press **🏠/HOME** or **📞** to dial.

### 📞NOTES

- The handset or telephone base shows the elapsed time as you talk (in hours, minutes and seconds).
- While entering numbers, press **DELETE** to make corrections; press and hold PAUSE to insert a dialing pause (a **p** appears).

## Answer a home call

Press **🏠/HOME**, **📞/CELL**, **📞/CELL 1**, **📞**, or any dialing key (**0-9**, **#** or **\*tone**) to answer.

## End a home call





Press **OFF** on the handset or **🏠/HOME** on the telephone base, place the handset in the telephone base or handset charger.

## Call waiting on the home line

When you subscribe to call waiting service with your telephone service provider, the handset flashes  and you hear a beep if someone calls while you are already on a call.

- Press **FLASH** on the handset or telephone base to put your current call on hold and take the new call.
- Press **FLASH** on the handset or telephone base at any time to switch back and forth between calls.

## Make a cell call

1. Press /CELL 1 or /CELL 2 on the handset or telephone base.
2. Enter the telephone number, and then press /CELL 1, /CELL 2 or **DIAL** to dial.
  - The screen displays **Unable to complete call. Check cellular.** if your cell phone is in use.

### NOTES

- The handset or telephone base shows the elapsed time as you talk (in hours, minutes and seconds).
- While entering numbers, press **DELETE** to make corrections; press and hold PAUSE to insert a dialing pause (a **p** appears).
- While using the cell line, place your cell phone closer to the telephone base, and make sure that there are no physical obstacles such as large furniture or thick walls between the telephone base and the cell phone.





## Predial a cell call

1. Enter the telephone number.
2. Press /CELL to dial.

### NOTES

- The screen displays **Unable to complete call. Check cellular.** if your cell phone is in use.
- The handset or telephone base shows the elapsed time as you talk (in hours, minutes and seconds).
- While entering numbers, press **DELETE** to make corrections; press and hold PAUSE to insert a dialing pause (a **p** appears).



## Answer a cell call

Press /CELL 1, /CELL 2, /HOME, , or any dialing key (**0-9, #** or **\*<sub>tone</sub>**) to answer.

### NOTE





You can also use your cell phone to answer the call. If you answer with your cell phone, it will disconnect from the telephone base.

## End a cell call

Press **OFF** on the handset or /CELL 1, /CELL 2 on the telephone base, place the handset in the telephone base or handset charger.

## Call waiting on the cell line



When you subscribe to call waiting service with your cell phone service provider, the handset flashes  and you hear a beep if someone calls while you are already on a call.

- Press /CELL 1 or /CELL 2 on the handset or telephone base to put your current call on hold and take the new call.
- Press /CELL 1 or /CELL 2 on the handset or telephone base at any time to switch back and forth between calls.

## Answer a cell call while on a home call

While you are on a home call and you receive an incoming cell call, you hear a beep, and your handset flashes . The telephone base and all other handsets ring.

### To answer the incoming cell call:

Press /CELL 1 or /CELL 2 on the handset or telephone base. The home line is put on hold.

### To resume the home call on hold:

Press /HOME on the handset or telephone base.



## Answer a home call while on a cell call

While you are on a cell call and you receive an incoming home call, you hear a beep, and your handset flashes . The telephone base and all other handsets ring.

### To answer the incoming home call:

Press /HOME on the handset or telephone base. The cell line is put on hold.



### To resume the cell call on hold:

Press /CELL 1 or /CELL 2 on the handset or telephone base.



## Conference home and cell calls

When you have calls established on the home and cell lines, you can create a 3-way conference.

### To conference both home and cell calls:

1. Press **OPTION** on the handset or telephone base.
2. Press  or  on the handset, or **CALLER ID/▼** or **PHONEBOOK/▲** on the telephone base to highlight **Conference**.
3. Press **SELECT**. The conferencing device's screen displays **Conf**.

### To select an option while on a conference call:

1. Press **OPTION** on the handset or telephone base.
2. Press  or  on the handset, or **CALLER ID/▼** or **PHONEBOOK/▲** on the telephone base to highlight one of the following options:
  - End Home line
  - End Cell 1 line
  - End Cell 2 line
  - Equalizer
  - Caller ID log
  - Directory
3. Press **SELECT**.

### To end a conference call:

- Press OFF on the handset or HOME on the telephone base; or put the handset back in the telephone base or charger.



## Using the home and cell lines together:

- You can be on two different calls at the same time using the cell line and home line with two handsets.
- You can be on a call using the cell line and a Bluetooth headset via the home line at the same time.
- If you are on a call using the cell line, you cannot join the call using your paired cell phone. However, you can join the call using another DS6291 device. Your cell phone is being used for the phone call so only features that are normally available during a call can be used.

## Speakerphone

When the handset is on a call, press **⏮** to switch between the handset speakerphone and earpiece. When the speakerphone is active, the handset displays **⏮**).

## Volume control

During a call on the handset, press **VOLUME/⏮** or **VOLUME/⏭** to adjust the listening volume.

During a call on the telephone base, press **▼/VOL/▲** to adjust the listening volume.

If this is a cell call and the volume is too loud or quiet, try changing the volume on your cell phone. On some cell phones, changing the volume on the cell phone affects your cell call volume on the **DS6291** handset or telephone base.

### 📌NOTES

- The handset and speakerphone volume settings are independent. The speakerphone volume setting of the telephone base is also independent.
- If the handset ringer volume is set to off, that handset is silenced for all incoming calls except paging tone.

## Mute

The mute function allows you to hear the other party but the other party cannot hear you.

- During a call, press **MUTE** on the handset or telephone base. The screen displays **Muted** until the mute function is turned off.
- Press **MUTE** on the handset or telephone base again to resume the conversation. The screen briefly displays **Microphone ON**.

## Equalizer

The equalizer feature enables you to change the quality of the audio to best suit your hearing.

### Using a cordless handset or the telephone base:

1. While on a home call or cell call, press **OPTION**.
2. Press **⏮** or **⏭** on the handset, or **CALLER ID/▼** or **PHONEBOOK/▲** to highlight **Equalizer**, and then press **SELECT**.
3. Press **⏮** or **⏭** on the handset, or **CALLER ID/▼** or **PHONEBOOK/▲** to select **Treble 1**, **Treble 2**, **Bass** or **Natural** (the default setting), and then press **SELECT**.

### 📌NOTES

- If you switch the call between the handset and speakerphone by pressing **⏮**, the audio setting remains unchanged.
- The current equalizer setting remains unchanged until you select a new setting.

## Chain dialing

Use this feature to initiate a dialing sequence from numbers stored in the directory, caller ID log or redial list while you are on a call.

Chain dialing can be useful if you wish to access other numbers (such as bank account numbers or access codes) from the directory, caller ID log or redial list.

### To access a number from the directory while on call:

1. Press **OPTION**.
2. Press  $\vee$  or  $\wedge$  on the handset, or **CALLER ID/▼** or **PHONEBOOK/▲** on the telephone base to scroll to **Directory**, and then press **SELECT**.
3. Press  $\vee$  or  $\wedge$  on the handset, or **CALLER ID/▼** or **PHONEBOOK/▲** on the telephone base to scroll to the desired directory, and then press **REVIEW**.
4. Press  $\vee$  or  $\wedge$  on the handset, or **CALLER ID/▼** or **PHONEBOOK/▲** on the telephone base to highlight the desired entry or perform an alphabetical search.
5. Press **DIAL** to dial the number shown.

### To access a number from the caller ID log while on a call:

1. Press **OPTION**.
2. Press  $\vee$  or  $\wedge$  on the handset, or **CALLER ID/▼** or **PHONEBOOK/▲** on the telephone base to scroll to **Caller ID log**, then press **SELECT**.
3. Press  $\vee$  or  $\wedge$  on the handset, or **CALLER ID/▼** or **PHONEBOOK/▲** on the telephone base to scroll to the desired entry, then press **CALL** to dial the number shown.

### To access a number from the redial list while on a call:

1. Press **REDIAL** to show the most recently dialed number.
2. Press  $\vee$  or  $\wedge$  on the handset, or **CALLER ID/▼** or **PHONEBOOK/▲** on the telephone base to scroll to the desired number, or press **REDIAL** repeatedly to find the desired number. Press **DIAL** to dial the number shown.

## Temporary tone dialing

If you have pulse (rotary) service only, you can switch from pulse to touch-tone dialing temporarily during a call. This is useful if you need to send touch-tone signals to access your telephone banking or long distance services.

1. During a call, press  $\star$ tone.
2. Use the dialing keys to enter the number you wish to dial.
3. The telephone sends touch-tone signals. The telephone automatically returns to pulse dialing mode after you end the call.

## Hold

You can place any call on hold. You hear an alert tone at the telephone base if you have not taken the call off of hold after 14 minutes. You hear another alert tone at the telephone base 30 seconds later. At 15 minutes on hold, the call on hold automatically disconnects.

### To place a home call on hold:

- Press **HOLD** on the handset or telephone base. Home call on hold appears on the handsets and telephone base. **HOME** flashes on the handsets and the telephone base.

### To resume a home call on hold:

- Press /HOME on the handset and the telephone base.

### To place a cell call on hold:

- Press **HOLD** on the handset or telephone base. **Cell 1/2 call on hold** appears on the handsets and telephone base. /CELL 1 or /CELL 2 on the handsets and on the telephone base flash.

### To resume a cell call on hold:

- Press /CELL 1 or /CELL 2 on the handset or telephone base.

## Find handset

This feature helps you find misplaced handsets.

### To start the paging tone:

- Press /FIND HANDSET on the telephone base.  
All idle handsets ring and their screens display **\*\* Paging \*\***.

### To stop the paging tone:

- Press /HOME, /CELL, **OFF**, or any dialing key (**0-9**, **#** or **\*<sub>(tone)</sub>**) on a handset.

**-OR-**

- Press /FIND HANDSET on the telephone base.

**-OR-**

- Place the handset in the telephone base or charger.

#### NOTE

Press **MUTE** to turn off the ringer of a handset temporarily. Paging tone continues on all other handsets.

## Join a call in progress

Another handset can join you on a home call. That call continues until all parties hang up. You can share an outside call with up to four handsets at the same time.

You can buy additional expansion handsets (**DS6290**) for this telephone base. You can register up to 12 devices to the telephone base.

### To join a call:

- When a handset is already on a call, press /HOME or on another handset to join the call.
- Press **OFF** or place the handset in the telephone base or handset charger to exit the call. The call continues on the other handset until both handsets hang up.

#### NOTE

- If you have paired a DECT 6.0 cordless headset and speakerphone to the telephone base, you can also join a call in progress using the paired device. Refer to the user's manuals of the respective product for more information.

# Intercom

Use the intercom feature for conversations between two handsets, or a handset and the telephone base. You can buy additional expansion handsets (**DS6290**) for this telephone base to expand your telephone system (up to 12 handsets).

## Initiate, answer, and end an intercom

### Using a cordless handset:

1. Press **MENU** in idle mode to enter the main menu. Press  $\vee$  or  $\wedge$  to scroll to **Intercom**, then press **SELECT**.
  - If you have one handset, the handset shows **Calling base**.
  - If you have more than one handset, the handset shows **INTERCOM TO**: Use the dialing keys to enter a specific device number (**0** for the telephone base, **1-9** for handsets 1-9, **TONEX** followed by **0-2** for handsets 10-12, or **TONE X** followed by **#** for all devices), or press  $\vee$  or  $\wedge$  to scroll to the desired device and press **SELECT**. Your handset screen shows **Calling HANDSET X**, **Calling BASE 0** or **Calling all**.

The destination device(s) rings and shows **HANDSET X is calling** or **HANDSET X is calling all** (**HANDSET** represents the handset name, **X** represents the handset number).

2. To answer the intercom call, press **HOME**, **CELL 1**, **CELL 2** or any dialing key (**0-9**, **TONEX**) on the destination handset, or press **HOME** on the telephone base. Both devices now show **Intercom**.

3. To end the intercom call, press **END**, **CANCEL**, or place the handset back in the telephone base or charger; or press **END** on the telephone base. The other party hears four beeps. Both devices display **Intercom ended**.

### Using the telephone base:

1. Press **MENU** in idle mode to enter the main menu. Press **CALLER ID / ▼** or **PHONEBOOK / ▲** to scroll to **Intercom**, then press **SELECT**.
  - If you have one handset, the telephone base shows **Calling HANDSET X**.
  - If you have more than one handset, the telephone base shows **INTERCOM TO**: Use the dialing keys to enter a specific handset number (**1-9** for handsets 1-9, **TONEX** followed by **0-2** for handsets **10-12**, or **TONEX** followed by **#** for all handsets), or press **CALLER ID / ▼** or **PHONEBOOK / ▲** to scroll to the desired handset and press **SELECT**. The telephone base shows **Calling HANDSET X** or **Calling all**.

The destination handset(s) rings and shows **Base is calling**, **BASE 0 is calling** or **BASE 0 is calling all**.

2. To answer the intercom call, press **HOME**, **CELL 1**, **CELL 2** or any dialing key (**0-9**, **TONEX**) on the destination handset. Both the base and the handset now show **Intercom**.
3. To end the intercom call, one party press **END**, **CANCEL**, or place the handset back in the telephone base or charger; or press **END** on the telephone base. The other party hears four beeps. Both devices display **Intercom ended**.

## NOTES

- Before the intercom call is answered, you can cancel it by pressing **CANCEL** on the handset or **END** on the telephone base.
- If the called device is not answered within 100 seconds, or accessing the directory or caller ID log, or is on a call, or is out of range, the initiating device shows **No answer. Try again.**
- To temporarily silence the intercom ringer, press **CANCEL** or **MUTE** on the handset or telephone base.
- You can only use one pair of devices at a time to make intercom calls.

## Answer an incoming call during an intercom call

When you receive an incoming home call during an intercom call, the two handsets on the intercom call hear an alert tone.

### Using a handset:

- Press **HOME** to answer the home call. The intercom call ends automatically.
- Press **CANCEL** to end the intercom call without answering the incoming call. The telephone continues to ring.

### Using the telephone base:

- Press **HOME** to answer the home call and the intercom call ends automatically.
- Press **BACK** and then **END** to end the intercom call without answering the incoming call. The telephone continues to ring.

## To answer a cell call during an intercom call:

When you receive an incoming cell call during an intercom call, the two handsets on the intercom call hear an alert tone.

## Using a handset:

- Press **CELL 1** or **CELL 2** to answer the cell call and the intercom call ends automatically.

## Using the telephone base:

- Press **CELL 1** or **CELL 2** to answer the cell call. The intercom call ends automatically.

## Call transfer using intercom

Use the intercom feature to transfer an outside call to another system handset or the telephone base. You can also share an outside call with another system handset or the telephone base.

## Using a cordless handset:

1. During the call, press **OPTION**.
2. Press **SELECT** to choose **Intercom**.
  - If you have one handset, the handset shows **Calling base**.
  - If you have more than one handset, the handset shows **INTERCOM TO**: Use the dialing keys to enter a specific device number (**0** for the telephone base, **1-9** for handsets **1-9**, **TONEX** followed by **0-2** for handsets **10-12**, or **TONEX** followed by **#** for all devices), or press **↓** or **↑** to scroll to the desired device and press **SELECT**.

The call is automatically put on hold. Your handset screen shows **Calling HANDSET X**, **Calling BASE 0** or **Calling all**. The destination device rings and displays **HANDSET X is calling**, or **HANDSET X is calling all**.

3. To answer the intercom call on the other device, press **HOME/FLASH**, **SPEAKER**, **CELL 1**, **CELL 2** or any dialing key (**0-9**, **TONEX**) on the destination handset, or press **HOME** on the telephone base.
4. From this intercom call, you have the following options:

- You can transfer the call. Press **OPTION** and then press **SELECT** to select Transfer on the calling handset. Your screen shows Call transferred. The other device automatically connects to the outside call.
- You can let the other device join you on the outside call in a three-way conversation. Press **OPTION**. Press  $\vee$  or  $\wedge$  to highlight Share call, then press **SELECT**.
- You can end the intercom call and continue the outside call with your handset. Press **CANCEL**, **END**,  $\text{HOME}$ ,  $\text{CELL 1}$  or  $\text{CELL 2}$  on your handset (the ended intercom call party hears four beeps).

#### NOTES

- If you want to cancel an intercom call and reconnect to the outside call before the destination handset answers, press **CANCEL** on the originating handset.
- If the called device is not answered within 100 seconds, or accessing the directory or caller ID log, or is on a call, or is out of range, the initiating device shows **No answer. Try again.**

## Using the telephone base:

1. During the call, press **OPTION**.
2. Press **SELECT** to choose **Intercom**.
  - If you have one handset, the handset shows **Calling HANDSET**.
  - If you have more than one handset, the handset shows **INTERCOM**  
**TO:** Use the dialing keys to enter a specific handset number (**1-9** for handsets 1-9, **TONE $\times$**  followed by **0-2** for handsets 10-12, or **TONE $\times$**  followed by **#** for all handsets), or press **CALLER ID/**  $\blacktriangledown$  or **PHONEBOOK/**  $\blacktriangle$  to scroll to the desired device and press **SELECT**.

The call is automatically put on hold. Your handset screen shows **Calling HANDSET X** or **Calling all**. The destination handset(s) rings and displays **BASE 0 is calling**.

3. To answer the call on any destination handset, press  $\text{HOME}$ ,  $\text{CELL 1}$ ,  $\text{CELL 2}$  or any dialing key (**0-9**, **TONE $\times$** ). Both the handset and the telephone base now show **Intercom**.
4. From this intercom call, you have the following options:
  - You can transfer the call. Press **OPTION** and then press **SELECT** to select Transfer on the telephone base. The telephone base shows Call transferred. The destination handset automatically connects to the outside call.
  - You can let the handset join you on the outside call in a three-way conversation. Press **OPTION**. Press **CALLER ID/**  $\blacktriangledown$  or **PHONEBOOK/**  $\blacktriangle$  to highlight Share call, then press **SELECT**.
  - You can end the intercom call and continue the outside call on the telephone base. Press **CANCEL**, **END**,  $\text{CELL 1}$ , or  $\text{CELL 2}$  on the telephone base. The destination handset shows Intercom ended.

#### NOTES

- To cancel the transfer call and return to the external call before the intercom call is answered, press **CANCEL** on the telephone base.
- If the other handset does not answer the intercom call within 100 seconds, or if the other handset is in the directory or caller ID log, or is out of range, the initiating device shows **No answer. Try again.** and returns to the outside call.

## Push-to-talk (PTT)

You can directly broadcast messages to the speakerphone of any device.

Press and hold **PUSH TO TALK** on a handset or **PTT** on the telephone base to begin two-way communication.

- Only one device can talk at a time. While talking to another device, press and hold **PUSH TO TALK** on the handset or **PTT** on the telephone base.
- You must release **PUSH TO TALK** on the handset or **PTT** on the telephone base, so the other person can respond.
- Only one PTT session can be active at a time.
- While PTT is in use between two devices, other devices cannot use the intercom feature but can access the answering system.
- When you attempt to place a PTT call to another device which is accessing the answering system or on an intercom call or outside call, your device screen shows Not available at this time.

### NOTE

The PTT function is not available when **QUIET** mode is on.

## Turn PTT on or off

### Using a cordless handset or the telephone base:

1. Press **PUSH TO TALK** when the handset is not in use. The **PUSH TO TALK** menu displays.
2. Press  $\vee$  or  $\wedge$  on the handset, or **CALLER ID/  $\blacktriangledown$**  or **PHONEBOOK/  $\blacktriangle$**  on the telephone base to highlight **PTT On/Off**, then press **SELECT**.
3. Press  $\vee$  or  $\wedge$  on the handset, or **CALLER ID/  $\blacktriangledown$**  or **PHONEBOOK/  $\blacktriangle$**  on the telephone base to choose **On** or **Off**, then press **SELECT**.

### NOTE

The handset or the telephone base screen displays **No PTT call when PTT is turned off**.

## PTT call to single device

### Using a cordless handset:

1. There are a few ways to begin a PTT call to a single device. When the handset is not in use:
    - If you have one handset, press and hold **PUSH TO TALK**.
    - If you have more than one handset:
      - ◆ Press **PUSH TO TALK** on the handset, then use the dialing keys to enter the destination device number.
- OR-**
- ◆ Press **PUSH TO TALK** on the handset. Press  $\vee$  or  $\wedge$  on to highlight the destination device number, then press **SELECT** or **PUSH TO TALK**.

The handset shows **Connecting to HANDSET X...** (**HANDSET** represents the handset name, **X** represents the destination handset number) or **Connecting to BASE 0...** (**BASE** represents the base name) for a few seconds. When the connection is made, both your and the destination device screens display **Press and hold [PTT] to talk**.

2. **Press and hold PUSH TO TALK**. A chirp indicates your microphone is on. Speak towards the device. Your voice is broadcast to the destination device. While you are speaking, your handset shows **PTT To HANDSET X** or **PTT To BASE 0**.
3. Release **PUSH TO TALK** after speaking. Both devices beep once again and the screens show **Press and hold [PTT] to talk**, then you can press and hold PUSH TO TALK to continue speaking or the destination device can respond (see **Answer a PTT call**).
4. To end the PTT call, press **CANCEL** or **END**, or place the handset in the telephone base or charger. The handset shows **Push to talk ended**.

 **NOTE**

After **PUSH TO TALK** is released, the PTT call remains open for a short time. If no one presses **PUSH TO TALK** within 10 seconds, the PTT call ends automatically.

## Using the telephone base:

1. There are a few ways to begin a PTT call to a single handset. When the telephone base is not in use:
  - If you have one handset, press and hold PTT.

- If you have more than one handset:
  - ♦ Press **PTT**, then use the dialing keys to enter the destination handset number.

**-OR-**

- ♦ Press **CALLER ID/▼** or **PHONEBOOK/▲** on the telephone base to highlight the destination handset number, then press **SELECT** or **PTT**.

The telephone base shows **Connecting to HANDSET X...** (**HANDSET** represents the handset name, **X** represents the destination handset number) for a few seconds. When the connection is made, both the telephone base and destination handset display **Press and hold [PTT] to talk**.

2. **Press and hold PTT**. A chirp indicates your microphone is on. Speak towards the telephone base. Your voice is broadcast to the destination handset. While you are speaking, the telephone base shows **PTT To HANDSET X**.
3. Release **PTT** after speaking. Both devices beep once again and the screens show **Press and hold [PTT] to talk**, then you can press and hold PTT to continue speaking or the destination device can respond (see **Answer a PTT call**).
4. To end the PTT call, press **CANCEL** or **END**. The telephone base shows **Push to talk Ended** for a few seconds.

 **NOTE**

After **PTT** is released, the PTT call remains open for a short time. If no one presses **PTT** within 10 seconds, the PTT call ends automatically.



## PTT call to multiple devices

When there are multiple handsets registered to the phone system, PTT supports one-to-group calls. PTT supports a maximum of one-to-four calls when one to five handsets are registered, and a maximum of one-to-three calls when six or more handsets are registered. The first three or four registered handsets will be able to use this feature. Other handsets can only use PTT for one-to-one calls.

### To call multiple devices:

#### Using a cordless handset:

1. You have two ways to call multiple devices. When the handset is not in use:
  - Press and hold **PUSH TO TALK** until the handset shows Connecting to group...
  - Press **PUSH TO TALK**. Press  $\vee$  or  $\wedge$  to choose Group. Press **SELECT** or press **PUSH TO TALK** and your handset shows Connecting to group...

When the connection is made, both the caller and the destination parties hear a beep. The speakerphones on all other devices automatically activate.

2. You need to press and hold **PUSH TO TALK** when you want to speak. Speak towards the handset. Your voice is broadcast to all devices.
3. Release **PUSH TO TALK** after speaking.
4. Any extension can reply (see **Answer a PTT call**).

#### NOTE

After **PUSH TO TALK** is released, the PTT call remains open for a short time. If no one presses **PUSH TO TALK** within ten seconds, the PTT call ends automatically.

## Using the telephone base:

1. You have two ways to call multiple handsets. When the telephone base is not in use:
  - Press and hold **PTT** until the screen shows **Connecting to group....**
  - Press **PTT**. Press **CALLER ID/▼** or **PHONEBOOK/▲** to choose Group. Press **SELECT** or press **PTT** and the telephone base shows **Connecting to group....**

When the connection is made, both the caller and the destination parties hear a beep. The speakerphones on all other devices automatically activate.

2. You need to press and hold **PTT** when you want to speak. Speak towards the telephone base. Your voice is broadcast to all devices.
3. Release **PTT** after speaking.
4. Any extension can reply (see **Answer a PTT call**).

#### NOTE

After **PTT** is released, the PTT call remains open for a short time. If no one presses **PTT** within 10 seconds, the PTT call ends automatically.

## Answer a PTT call

You can respond to a PTT call as described below.

### Using a handset or the telephone base:

1. When your device receives a PTT call, it beeps and shows **Press and hold [PTT] to talk**.
2. When the other party is speaking, your speakerphone light is on, and your device shows:
  - **PTT From HANDSET X To devices: X** (the first **X** represents the initiating handset number, and the second **X** represents your handset number; a maximum of four handset numbers appear).

**-OR-**

- **PTT From BASE 0 To devices: X** (the **X** represents your handset number; a maximum of four handset numbers appear).
3. When your speakerphone light is off (the screen shows **Press and hold [PTT] to talk**), press and hold **PUSH TO TALK** on your handset or **PTT** on your telephone base. You will hear a chirp. Speak towards the device.
    - While you are speaking, your device shows **PTT To Handset: X** (**X** represents the handset numbers of one or more destination handsets; a maximum of four handset numbers appear) or **PTT To devices: X** (**X** represents the handset numbers of one or more destination handsets; a maximum of four handset numbers appear).
    - Your voice is broadcast to all destination devices.

After speaking, release **PUSH TO TALK** on your handset or **PTT** on your telephone base. Your device will beep. After the beep, if your speakerphone light is off, you can press and hold **PUSH TO TALK** on your handset or **PTT** on your telephone base to continue speaking, or the destination device can respond.

### Change a one-to-one PTT call to an intercom call

You can convert a one-to-one PTT session to an intercom call.

### Using a handset or the telephone base:

1. When your device shows **Press and hold [PTT] to talk**, press **INTCOM**. The screen shows **Switch to Intercom?**
2. Press **SELECT**. Your device displays **Calling BASE 0** or **Calling HANDSET X**. The destination device briefly shows **Push to talk Ended** and then **HANDSET X is calling** or **BASE 0 is calling**. The destination device rings.
3. Press **HOME/FLASH** or any dialing keys (**0-9**, or **TONEX**) on the destination handset, or press **HOME** or any dialing keys (**0-9**, or **TONE X**) on the telephone base to answer the intercom call. Both devices now show **Intercom**.
4. To end the intercom call, press **OFF** on your handset or place the handset in the telephone base or charger, or press **END** on the telephone base. Both screens show **Intercom ended**.

## Answer an incoming call during a PTT call

When you receive an outside call during PTT, there is an alert tone.

### Using a handset or the telephone base:

- During a one-to-one PTT call, press **HOME**, **CELL 1** or **CELL 2** on the initiating or destination handset, or press **HOME**, **CELL 1** or **CELL 2** on the telephone base. The PTT call ends automatically and the outside call is answered.
- During a one-to-group PTT call, press **HOME**, **CELL 1** or **CELL 2** on the initiating handset, or press **HOME**, **CELL 1** or **CELL 2** on the telephone base. The PTT call ends automatically and the outside call is answered.
- During a one-to-group PTT call, press **HOME**, **CELL 1** or **CELL 2** on any one of the destination handsets or telephone base. That device answers the outside call. The PTT call continues for the rest of the PTT participants.
- To leave the PTT call without answering the incoming call, press **OFF** on your handset or **CANCEL** on your telephone base. The telephone continues to ring.

## Make an outgoing call during PTT call

### Using a handset or the telephone base:

- During a one-to-one PTT call, press **HOME** on your handset or telephone base to get a dial tone. The PTT call ends automatically.
- During a one-to-group PTT call, press **HOME** on the initiating handset or telephone base. The PTT call ends automatically and you get a dial tone.
- During a one-to-group PTT call, press **HOME** on any one of the destination handsets or telephone base. That device gets a dial tone. The PTT call continues for the rest of the PTT participants.

## End or leave a PTT call

### Using a handset or the telephone base:

For one-to-one PTT calls, both initiating and destination devices can end the PTT call. For PTT calls to multiple devices, the initiating device can end the PTT call. If any one of the destination devices leaves the PTT call, the call continues until all participants or the initiator hangs up.

Press **CANCEL** or **END** on the handset or telephone base. The screen shows **Push to talk Ended**.

**-OR-**

Place the handset in the telephone base or charger, then the handset return to idle mode.

#### NOTE

After **PUSH TO TALK** on the handset or **PTT** on the telephone base is released, the PTT call remains open for a short time. If no one presses **PUSH TO TALK** on the handset or **PTT** on the telephone base within ten seconds, the PTT call ends automatically.





## Redial

The base and each handset store the last 10 telephone numbers dialed. When there are already 10 entries, the oldest entry is deleted to make room for the new entry.



### Review a redial list entry

1. Press **REDIAL** on the handset or telephone base when idle.
2. Scroll or press **REDIAL** repeatedly until the desired entry displays.

### Dial a redial list entry



1. Press **REDIAL** on the handset or telephone base when idle.
2. Scroll or press **REDIAL** repeatedly until the desired entry displays.
3. Press /HOME, /CELL 1, /CELL 2, or  to dial.

**-OR-**



1. Press /HOME or  to use the home line.

**-OR-**

Press /CELL to use the cell line.

2. Press **REDIAL** to enter the redial list.
  1. Press ,  or **REDIAL** repeatedly on the handset; or press **CALLER ID/ ▼** or **PHONEBOOK/ ▲** or **REDIAL** repeatedly to browse until the desired entry displays.
  2. Press **SELECT** to dial the displayed number.

### Delete a redial list entry

1. Press **REDIAL** to enter the redial list.
2. Press ,  or **REDIAL** repeatedly on the handset; or press **CALLER ID/ ▼** or **PHONEBOOK/ ▲** or **REDIAL** repeatedly to browse until the desired entry displays.
  - When the handset displays the number you want to delete, press **DELETE**.

# Directory

The directory can store up to 200 entries, which are shared by all handsets. Each entry may consist of a telephone number up to 30 digits, and a name up to 15 characters.

Each handset directory is independent (for multiple handset models only). Any additions, deletions or edits made on one handset are not reflected on other handsets.

If the telephone number in the directory exceeds 15 digits, a dash appears after the 14th digit and then the remaining digits are shown beginning with a dash alternately.

## Add a home directory entry

### Using a handset and telephone base:

1. Press **MENU** on the handset in idle mode to enter the main menu.
2. Press  $\vee$  or  $\wedge$  on the handset, or **CALLER ID/  $\blacktriangledown$**  or **PHONEBOOK/  $\blacktriangle$**  on the telephone base to scroll to **Directory**, then press **SELECT**.
3. Press **OPTION** to choose **Home**.
4. Press **SELECT** to choose **Add contact**. The screen displays **Enter number**.
5. Use the dialing keys to enter a telephone number.

**-OR-**

Copy a number from the redial list. Press **REDIAL** and then  $\vee$  or  $\wedge$  on the handset, or **CALLER ID/  $\blacktriangledown$**  or **PHONEBOOK/  $\blacktriangle$**  on the telephone base, or **REDIAL** repeatedly to locate the number. Press **INSERT** to copy the displayed number.

6. Press **NEXT**.

7. Press  $\vee$  or  $\wedge$  on the handset, or **CALLER ID/  $\blacktriangledown$**  or **PHONEBOOK/  $\blacktriangle$**  on the telephone base to highlight one of the following types:

- Home
- Cell
- Work
- Other

8. Press **NEXT**. The screen displays **Enter name**.
9. Use the dialing keys to enter a name (up to 15 characters).
10. Press **SAVE** to confirm and the screen shows **Saved**. You hear a confirmation tone.

### While entering names and numbers, you can:

- Press  $\vee$  or  $\wedge$  on the handset, or **CALLER ID/  $\blacktriangledown$**  or **PHONEBOOK/  $\blacktriangle$**  on the telephone base to move the cursor to the left or right.
- Press **DELETE** to erase a digit.
- Press and hold **DELETE** to erase all digits.
- Press and hold **PAUSE** to enter a dialing pause (a **p** appears).
- Press **0** to add a space.
- Press **a>A** to change the next letter to upper or lower case.

## Add a predialed telephone number to the directory

You can save a predialed telephone number to the directory.

### Using a handset or telephone base:

1. Enter the telephone number when in idle mode, then press **SAVE** to move on to edit the number and then press **NEXT**.

2. Press **▼** or **▲** on the handset, or **CALLER ID/▼** or **PHONEBOOK/▲** on the telephone base to highlight one of the following types:

- Home
- Cell
- Work
- Other

3. Press **NEXT**. The screen displays **Enter name**.
4. Use the dialing keys to edit the name.
5. Press **SAVE** to save the entry. There is a confirmation tone and the screen shows **Saved**.

## Review directory entries

Directory entries appear alphabetically.

### Using a handset or telephone base:

1. Press **☞** on the handset or **PHONEBOOK** on the telephone base when in idle mode.
2. Press **▼** or **▲** on the handset, or **CALLER ID/▼** or **PHONEBOOK/▲** on the telephone base to highlight a directory, then press **REVIEW**.
3. Press **▼** or **▲** on the handset, or **CALLER ID/▼** or **PHONEBOOK/▲** on the telephone base to browse.

**-OR-**

1. Press **MENU** when in idle mode.
2. Press **▼** or **▲** on the handset, or **CALLER ID/▼** or **PHONEBOOK/▲** on the telephone base to highlight **Directory**, then press **SELECT**.
3. Press **▼** or **▲** on the handset, or **CALLER ID/▼** or **PHONEBOOK/▲** on the telephone base to highlight a directory, then press **REVIEW**.
4. Press **▼** or **▲** on the handset, or **CALLER ID/▼** or **PHONEBOOK/▲** on the telephone base to browse.

**-OR-**

1. Press **OPTION** while on a call.
2. Press **▼** or **▲** on the handset, or **CALLER ID/▼** or **PHONEBOOK/▲** on the telephone base to highlight **Directory**, then press **SELECT**.
3. Press **▼** or **▲** on the handset, or **CALLER ID/▼** or **PHONEBOOK/▲** on the telephone base to highlight a directory, then press **REVIEW**.
4. Press **▼** or **▲** on the handset, or **CALLER ID/▼** or **PHONEBOOK/▲** on the telephone base to browse.

### NOTES

- When the desired entry displays, press # (pound key) on the handset or telephone base repeatedly to show different dialing options.
- **Directory empty** appears if there are no directory entries.

## Alphabetical search

1. Follow the steps in **Review directory entries** to enter the directory.
2. Use the dialing keys to enter the letters associated with the name. You can enter up to 3 letters for the search. The letters will show at the top left hand corner of the screen. After you have entered one to three letters, the system starts searching in the directory. If there is no name matching the letter(s) entered, the next closest match in alphabetical order appears. If necessary, press **▼** or **▲** on the handset, or **CALLER ID/▼** or **PHONEBOOK/▲** on the telephone base to browse.

## Delete a phonebook entry

1. Search for the desired entry in the phonebook (see **Review phonebook entries** or **Alphabetical search**).
2. Press **DELETE** and then the handset displays **Delete entry?**
3. Press **SELECT** to confirm. The handset displays **Deleting...** You hear a confirmation tone and then the handset returns to the previous menu.

## Edit a directory entry

### Using a handset or telephone base:

1. Search for the desired entry in the directory (see **Review directory entries** or **Alphabetical search**).
2. When a directory entry displays, press **EDIT**. The screen shows **Edit number** along with the phone number to be edited.
3. Use the dialing keys to edit the number:
4. Press **NEXT**.
5. Press  $\vee$  or  $\wedge$  on the handset, or **CALLER ID/▼** or **PHONEBOOK/▲** on the telephone base to highlight one of the following types.
  - Home
  - Cell
  - Work
  - Other
6. Press **NEXT**. The screen displays **Edit name**.
7. Use the dialing keys to edit the name.
8. Press **SAVE** to save the entry. There is a confirmation tone and the screen shows **Saved**.

### While entering names and numbers, you can:

- Press  $\vee$  or  $\wedge$  on the handset, or **CALLER ID/▼** or **PHONEBOOK/▲** on the telephone base to move the cursor to the left or right.
- Press **DELETE** to erase a digit.
- Press and hold **DELETE** to erase all digits.
- Press and hold **PAUSE** to enter a dialing pause (a **p** appears).
- Press **0** to add a space.
- Press **a>A** to change the next letter to upper or lower case.

## Edit the type of a directory entry

### Using a handset or telephone base:

1. Search for the desired entry in the directory (see **Review directory entries** or **Alphabetical search**).
2. When a directory entry displays, press **LABEL**. Enter the corresponding shortcut keys shown on the screen.  
**-OR-**  
Press **CLEAR** to erase the assigned label

## Dial a directory entry

### Using a handset or telephone base:

1. Search for the desired entry in the directory (see **Review directory entries** or **Alphabetical search**).
2. When the desired entry appears, press # (pound key) repeatedly on the handset or telephone base to show different dialing options.
3. When the displayed number is in the correct format, press **HOME** or **HOME** on the handset, or press **HOME** on the telephone base to use the home line. Press **CELL 1** or **CELL 2** on the handset or on the telephone base to use the cell line.

## Remove a downloaded directory

### Using a handset or telephone base:

1. Search for the desired downloaded directory in the directory menu (see **Review directory entries** and **Alphabetical search**).
2. When the desired downloaded directory is chosen, press **OPTION**, then press **▼** or **▲** on the handset, or **CALLER ID/▼** or **PHONEBOOK/▲** to highlight **Remove dir**.
3. Press **SELECT**. The screen displays **Directory Cell Phone A will be erased**.
4. Press **YES** to confirm. The handset displays **Erasing directory...** You hear a confirmation tone.

## Caller ID

If you subscribe to caller ID service, information about each caller appears after the first or second ring. If you answer a call before the caller information appears on the screen, it will not be saved in the caller ID log.

The caller ID log stores up to 50 entries. Each entry has up to 24 digits for the phone number and 15 characters for the name.

If the telephone number has more than 15 digits, only the last 15 digits appear.

If the name has more than 15 characters, only the first 15 characters are shown and saved in the caller ID log.

Entries appear in reverse chronological order. When the caller ID log is full, the oldest entry is deleted to make room for new incoming call information.

Caller ID log entries are shared by all system handsets (for multiple handset models only). Any deletions made on one handset are reflected on all other handsets.

### NOTE

This product can provide information only if both you and the caller are in areas offering caller ID service and if both telephone service providers use compatible equipment. The time and date are sent by your telephone service provider along with the call information.

## Review the caller ID log

Review the caller ID log to find out who called, to return the call, or to copy the caller's name and number into your phonebook.

1. Press **CID** when the phone is not in use. The handset displays **Entries in CID XX** for a few seconds.
2. Press **▼** or **▲** to browse.

**-OR-**



1. Press **MENU** when the phone is not in use.
2. Press  $\vee$  or  $\wedge$  to scroll to **Caller ID log**, and then press **SELECT** twice to choose **Review**. The handset displays **Entries in CID XX** for a few seconds.
3. Press  $\vee$  or  $\wedge$  to browse.

 **NOTE**

You hear a double beep when you reach the beginning or end of the caller ID log.

## Memory match

If the incoming telephone number matches the last seven digits of a telephone number in your phonebook, the name that appears on the screen matches the corresponding name in your phonebook.

For example, if Mike Smith calls, his name appears as **Mike** if this is how you entered it into your phonebook.

 **NOTE**

The number shown in the caller ID log will be in the format sent by the telephone service provider. The telephone service provider usually delivers 10-digit phone numbers (area code plus telephone number). If the phone number of the caller does not match a number in your phonebook, the name will appear as it is delivered by the telephone service provider.

## Missed call indicator

When there are calls that have not been reviewed in the caller ID log, the handsets display **XX Missed calls**.

When you have reviewed all the missed calls, the missed call indicator goes away.

Each time you review a caller ID log entry marked **NEW**, the number of missed calls decreases by one.

If you do not want to review the missed calls one by one, press and hold

**CANCEL** on the handset when not in use to clear the missed call indicator. All the entries are then considered old and kept in the caller ID log.

## View dialing options



Although the caller ID log entries received have 10 digits (the area code plus the seven-digit number), in some areas, you may need to dial only the seven digits, or **1** plus the seven digits, or **1** plus the area code plus the seven digits. You can change the number of digits that you dial from the caller ID log and store the new number to the phonebook.

While reviewing the caller ID log, press **#** (pound key) repeatedly to display different dialing options for local and long distance numbers before dialing or saving the telephone number in the phonebook.

Press **1** repeatedly if you need to add or remove 1 in front of the telephone number before dialing or saving it in the phonebook.

When the number is displayed in the correct format for dialing, Press **HOME** or  $\blacktriangleleft$  on the handset, or **HOME** on the telephone base to dial the displayed entry using the home line.

### -OR-

Press  **CELL 1** or  **CELL 2** on the handset or on the telephone base to dial the display entry using the cell line.



## Dial a caller ID log entry

1. Search for the desired caller ID log entry (see **Review the Caller ID log**).
2. When the desired entry displays, Press **HOME** or **◀** on the handset, or **HOME** on the telephone base to dial the displayed entry using the home line.

**-OR-**

Press **CELL 1** or **CELL 2** on the handset or on the telephone base to dial the display entry using the cell line.

## Save a caller ID log entry to the phonebook

1. Search for the desired caller ID log entry (see **Review the Caller ID log**).
2. When the desired entry appears, press # (pound key) repeatedly to show different dialing options.
3. When the number is in correct format, press **SAVE**. The screen displays **Edit number**.
4. Use the dialing keys to edit the number.
5. Press **NEXT**.
6. Press **▼** or **▲** on the handset, or **CALLER ID/▼** or **PHONEBOOK/▲** on the telephone base to highlight one of the following types:
  - Home
  - Cell
  - Work
  - Other
7. Press **NEXT**. The handset displays **Edit name**.
8. Use the dialing keys to edit the name.
9. Press **SAVE** to confirm. The screen shows **Saved**.

## While entering names and numbers, you can:

- Press **▼** or **▲** on the handset, or **CALLER ID/▼** or **PHONEBOOK/▲** on the telephone base to move the cursor to the left or right.
- Press **DELETE** to erase a digit.
- Press and hold **DELETE** to erase all digits.
- Press and hold **PAUSE** to enter a dialing pause (a **p** appears).
- Press **0** to add a space.
- Press **a>A** to change the next letter to upper or lower case.

### NOTE

If you save an entry which already exists in the phonebook, the handset displays **Number repeated** and then returns to previous screen.

## Delete the caller ID log entries

1. Search for the desired caller ID log entry (see **Review the Caller ID log**).
2. Press **DELETE** on the handset or the telephone base to delete the displayed entry.

## To delete all entries:

1. Press **MENU** when in idle mode.
2. Press **▼** or **▲** on the handset, or **CALLER ID/▼** or **PHONEBOOK/▲** on the telephone base to scroll to **Caller ID log**, then press **SELECT**.
3. Press **▼** or **▲** on the handset, or **CALLER ID/▼** or **PHONEBOOK/▲** on the telephone base to scroll to **Del all calls**, then press **SELECT**.
4. When the screen shows **Delete all calls?**, press **YES** to confirm. There is a confirmation tone and the screen returns to the previous menu.

# Sound settings

## Key tone

You can turn the key tone on or off for each handset. If you turn the key tone off, there are no beeps when you press the handset keys.

1. Press **MENU** in idle mode to enter the main menu.
2. Press  $\downarrow$  or  $\uparrow$  on the handset, or **CALLER ID/▼** or **PHONEBOOK/▲** on the telephone base to scroll to **Settings**, then press **SELECT**.
3. Press  $\downarrow$  or  $\uparrow$  on the handset, or **CALLER ID/▼** or **PHONEBOOK/▲** on the telephone base to scroll to **Key tone**, then press **SELECT**.
4. Press  $\downarrow$  or  $\uparrow$  on the handset, or **CALLER ID/▼** or **PHONEBOOK/▲** on the telephone base to select the desired volume or **Off**.
5. Press **SET** to save your preference. There is a confirmation tone and the screen returns to the previous menu.

## Ringer tone

You can choose from different ringer tones for each handset.





1. Press **MENU** when the phone is not in use.
2. Press  $\downarrow$  or  $\uparrow$  on the handset, or **CALLER ID/▼** or **PHONEBOOK/▲** on the telephone base to highlight **Ringers**, and then press **SELECT**.
3. Press **SELECT** to select **Ringer tone**.
4. Press  $\downarrow$  or  $\uparrow$  on the handset, or **CALLER ID/▼** or **PHONEBOOK/▲** to highlight **All lines**, **Home**, **Cell 1**, or **Cell 2**, then press **SELECT**.
5. Press  $\downarrow$  or  $\uparrow$  on the handset, or **CALLER ID/▼** or **PHONEBOOK/▲** to sample each ringer tone.
6. Press **SELECT** to save your selection. Then the handset returns to the previous menu. You hear a confirmation tone.

### NOTE

If you turn off the ringer volume, you will not hear ringer tone samples.

## Handset ringer volume

You can set the ringer volume or turn the ringer off on each handset. When the ringer is off,  appears on the screen.

1. Press **MENU** when the phone is not in use.
2. Press  or  on the handset, or **CALLER ID/▼** or **PHONEBOOK/▲** on the telephone base to highlight **Ringers**, and then press **SELECT**.
3. Press **SELECT** to select **Ringer volume**.
4. Press  or  on the handset, or **CALLER ID/▼** or **PHONEBOOK/▲** to sample each volume level.
5. Press **SELECT** to save your selection. Then the handset returns to the previous menu. You hear a confirmation tone.

### NOTE

The ringer volume also determines the ringer volume for intercom calls. If the ringer volume is set to off, that handset is silenced for all incoming calls except paging tone.

## Telephone base ringer volume

1. Press **▼/VOL/▲** on the telephone base to adjust the ringer volume when the telephone base is not in use.
2. Press **SET** to confirm and you hear a confirmation tone.

### NOTE

If the ringer volume is set to off, that telephone base is silenced for all incoming calls.

## Temporary ringer silencing

When the telephone is ringing, you can temporarily silence the ringer of the handset without disconnecting the call. The next call rings normally at the preset volume.

### To silence the handset ringer:

- Press **MUTE**, **MUTE**, **CANCEL**, or **QUIET #** on the handset or telephone base. The screen displays **Ringer muted** and .

### NOTES

- Each handset and the base ring when there is an incoming call unless the ringer volume of that device is turned off.
- You can also press **▼/VOL/▲** on the telephone base to adjust the ringer volume. The adjustment will be saved and applied to the next incoming call.

# About the built-in answering system and voicemail service

For message recording, your telephone has a built-in answering system, and it also support voicemail service offered by your telephone service provider (subscription is required, and fee may apply).

The main differences between them are as follows:

Category	Built-in answering system	Voicemail from telephone service
Storage	Messages are stored in the telephone base.	Messages are stored in a server or system provided by your telephone service.
	Your messages will not be deleted automatically. You have to delete your messages manually.	Your messages may be automatically deleted after a period of time. Contact your telephone service provider for more details.
Method to retrieve messages	When you received new messages, <b>OO</b> displays on both the handset and telephone base, <b>XX New msgs</b> displays on the handset, and <b>XX New messages</b> displays on the telephone base.	When you received new messages, the handset displays <b>✉</b> and <b>New voicemail</b> .
	To retrieve messages, usually there are two ways: <ul style="list-style-type: none"> <li>• Press a button on the telephone base; or</li> <li>• Access remotely with an access code.</li> </ul>	To retrieve messages, you need an access number and/or a passcode provided by your telephone service provider.

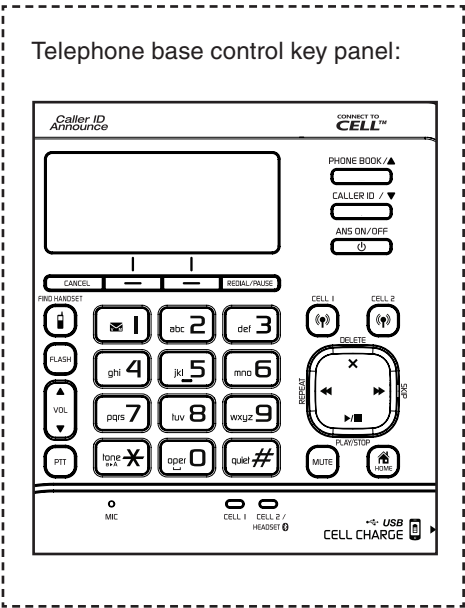

## Set your built-in answering system

The answering system can record and store up to 99 messages. Each message can be up to three minutes in length. The total storage capacity for the announcement, messages and memos is approximately 14 minutes. The actual recording time depends on individual message characteristics.

Your answering system allows you to set your announcement, to save and delete messages, activate call screening, to set number of rings before pick up, to access remotely, and to control the recording time.

### Turn the answering system on or off

The answering system must be turned on to answer and record messages.

When the answering system is turned on, the **ANS ON/OFF** light on the telephone base turns on and **ANS ON** displays on the handset.

### To turn on or off with the telephone base:

- Press **ANS ON/OFF** to turn the built-in answering system on or off. When the answering system is turned on, it announces, *"Calls will be answered."* When the answering system is turned off, it announces, *"Calls will not be answered."*

### To turn on or off with the handset:

1. When the handset is in idle mode, press **MENU** to enter the main menu.
2. Press **∨** or **∧** to scroll to **Answering sys**, then press **SELECT**.

3. Press **∨** or **∧** to scroll to **Answer On/Off**, then press **SELECT**.

4. Press **∨** or **∧** to highlight **On** or **Off**, then press **SELECT** to save the setting. You hear a confirmation tone.

### Default announcement

The telephone is preset with a greeting that answers calls with *"Hello, please leave a message after the tone."* You can use this preset announcement, or replace it with your own.

### Record your own announcement

#### Using a cordless handset or the telephone base:

The announcement can up to 90 seconds in length, but any announcement shorter than two seconds will not be recorded.

1. Press **MENU** when the phone is not in use.
2. Press **SELECT** to select **Answering sys**.
3. Press **SELECT** again to select **Announcement**.
4. Press **SELECT** to select **Record annnc**. The system announces, *"Record after the tone. Press STOP when you are done."*
5. Speak towards the telephone base to record your announcement. Press **STOP** to end recording. Your recorded announcement plays.

To listen to the recorded announcement again, scroll to **Play annnc** and press **SELECT**.

## Play your announcement

### Using a cordless handset or the telephone base:

1. Press **MENU** when the phone is not in use.
2. Press **SELECT** to select **Answering sys.**
3. Press **SELECT** again to select **Announcement.**
4. Press  $\vee$  or  $\wedge$  on the handset, or **CALLER ID/  $\blacktriangledown$**  or **PHONEBOOK/  $\blacktriangle$**  on the telephone base to scroll to **Play annnc**, then press **SELECT**.

## Delete your announcement

### Using a cordless handset or the telephone base:

1. Press **MENU** when the phone is not in use.
2. Press **SELECT** to select **Answering sys.**
3. Press **SELECT** again to select **Announcement.**
4. Press  $\vee$  or  $\wedge$  on the handset, or **CALLER ID/  $\blacktriangledown$**  or **PHONEBOOK/  $\blacktriangle$**  on the telephone base to scroll to **Play annnc**, then press **SELECT**.
5. While the announcement is playing, press **X/DELETE** to delete the announcement. The system announces "Announcement deleted".

### -OR-

1. When the telephone base is in idle mode, press **MENU** to enter the main menu.
2. Press **SELECT** to select **Answering sys.**
3. Press **SELECT** again to select **Announcement.**

4. Press  $\vee$  or  $\wedge$  on the handset, or **CALLER ID/  $\blacktriangledown$**  or **PHONEBOOK/  $\blacktriangle$**  on the telephone base to scroll to **Reset annnc**, then press **SELECT**. The screen shows **Reset to default annnc?**
5. Press **YES** to confirm. The screen shows **Annnc. reset to default.**

### NOTE

When your announcement is deleted, calls are answered with the preset announcement.

## Set number of rings

### Using a cordless handset or the telephone base:

1. When the handset is in idle mode, press **MENU** to enter the main menu.
2. Press  $\vee$  or  $\wedge$  on the handset, or **CALLER ID/  $\blacktriangledown$**  or **PHONEBOOK/  $\blacktriangle$**  on the telephone base to scroll to **Answering sys**, then press **SELECT**.
3. Press  $\vee$  or  $\wedge$  on the handset, or **CALLER ID/  $\blacktriangledown$**  or **PHONEBOOK/  $\blacktriangle$**  on the telephone base to scroll to **Ans sys setup**, then press **SELECT**.
4. Press  $\vee$  or  $\wedge$  on the handset, or **CALLER ID/  $\blacktriangledown$**  or **PHONEBOOK/  $\blacktriangle$**  on the telephone base to scroll to **# of rings**, then press **SELECT**.
5. Press  $\vee$  or  $\wedge$  on the handset, or **CALLER ID/  $\blacktriangledown$**  or **PHONEBOOK/  $\blacktriangle$**  on the telephone base to choose among **2, 3, 4, 5, 6** or **Toll saver**.
6. Press **SELECT** to save the setting. You hear a confirmation tone.

## Turn the call screening on or off

Use this feature to choose whether incoming messages can be heard while they are being recorded.

### Using a cordless handset or the telephone base:

1. When the handset or telephone base is in idle mode, press **MENU** to enter the main menu.
2. Press **▼** or **▲** on the handset, or **CALLER ID/▼** or **PHONEBOOK/▲** on the telephone base to scroll to **Answering sys**, then press **SELECT**.
3. Press **▼** or **▲** on the handset, or **CALLER ID/▼** or **PHONEBOOK/▲** on the telephone base to scroll to **Ans sys setup**, then press **SELECT**.
4. Press **SELECT** to select **Call screening**.
5. Press **▼** or **▲** on the handset, or **CALLER ID/▼** or **PHONEBOOK/▲** on the telephone base to choose **On** or **Off**.
6. Press **SELECT** to save the setting. You hear a confirmation tone.

## Turn the message alert tone on or off

When the message alert tone is set to on, and there is at least one new message, the telephone base beeps every 10 seconds. The message alert tone is preset to off.

### Using the handset or the telephone base:

1. When the telephone base is in idle mode, press **MENU** to enter the main menu.
2. Press **SELECT** to select **Answering sys**.
3. Press **▼** or **▲** on the handset, or **CALLER ID/▼** or **PHONEBOOK/▲** on the telephone base to scroll to **Ans sys setup**, then press **SELECT**.
4. Press **▼** or **▲** on the handset, or **CALLER ID/▼** or **PHONEBOOK/▲** on the telephone base to scroll to **Msg alert tone**, then press **SELECT**.
5. Press **▼** or **▲** on the handset, or **CALLER ID/▼** or **PHONEBOOK/▲** on the telephone base to choose **On** or **Off**.
6. Press **SELECT** to save the setting. You hear a confirmation tone.

#### NOTE

The answering system must be turned on for the message alert tone to be functional.



# Using your built-in answering system

## New message indication

**OO** and **XX New msgs** show on the handset and **XX New messages** shown on the telephone base when there are new answering system messages.

If the message alert tone is turned on, the telephone base beeps every 10 seconds when there are messages that have not been reviewed.

## Message playback

If you have new messages, the telephone plays only the new messages (oldest first). If there are no new messages, the telephone plays back all messages (oldest first).

When playback begins, you hear the total number of messages followed by the date and time of the message. After the last message, the telephone announces, “*End of messages.*”

### NOTE

Make sure you set the date and time correctly. Refer to **Set date and time** under the **Configure your telephone** section for more details.

## To play messages at the telephone base:

- Press **▶/■/PLAY** when the telephone base is not in use.

## Options during playback:

- Press **▲/VOL/▼** to adjust the speaker volume.
- Press **▶/SKIP** to skip to the next message.
- Press **◀/REPEAT** to repeat the message currently playing. Press **◀/REPEAT** twice to listen to the previous message.

- Press **X/DELETE** to delete the playing message. The system advances to the next message.
- Press **▶/■/STOP** to stop.
- Press **🏠/HOME**, **📶/CELL 1**, or **📶/CELL 2** to call back the caller if the message contains caller ID information. The telephone base screen displays **Call back?** with the caller ID information.
  - Press **CALL** to call back the caller.
  - Press **BACK** to restart the message playback.

## To play messages at the handset:

1. When the handset is in idle mode, press **MENU** to enter the main menu.
2. Press **SELECT** to select **Play messages**.
  - If there are new and old messages, press **▼** or **▲** to select **Play new msgs** or **Play old msgs**, then press **SELECT**.
  - If there are only new or only old messages, they will play automatically.

The system announces the number of messages, then begins playback. The message sequence is shown on the handset. If there are no recorded messages, the handset shows **No messages** and you hear, “You have no message.”

## Options during playback:

- Press **VOLUME/▼** or **VOLUME/▲** to adjust the message playback volume.
- Press **SKIP** to skip to the next message.
- Press **REPEAT** to repeat the message. Press **REPEAT** twice to listen to the previous message.
- Press **Delete** to delete the message.

- Press **⬆️/HOME**, **📞/CELL 1**, or **📞/CELL 2** to call back the caller if the message contains caller ID information. The telephone base screen displays **Call back?** with the caller ID information.
  - Press **CALL** to call back the caller.
  - Press **BACK** to restart the message playback.

#### 📌NOTES

- Only one handset or the telephone base can access the answering system at a time.
- During message playback, if there is an incoming call or another handset makes a call, message playback will be stopped.

## Delete all messages

You can only delete old (reviewed) messages. You cannot delete new messages until you review them. You cannot retrieve deleted messages.

### To delete all old messages at the telephone base:

1. When the phone is not in use, press **X/DELETE**. The system announces, *"To delete all old messages, press DELETE again."*
2. Press **X/DELETE** again. The system announces, *"All old messages deleted."* You hear a confirmation tone.

### To delete all old messages on a handset:

1. Press **MENU** when the phone is not in use.
2. Press **∨** or **∧** to scroll to **Answering sys**, and then press **SELECT**.
3. Press **∨** or **∧** to scroll to **Delete all old**, and then press **SELECT**. The handset shows **Delete all old message?**

4. Press **SELECT** to confirm. The handset displays **Deleting...** then **All old msgs deleted** and then returns to the previous menu. You hear a confirmation tone.

## Record, play, and delete memos

Memos are your own recorded messages used as reminders for yourself or others using the same answering system. You can record your own memos using a system handset. Each message can be up to 3 minutes in length. Play and delete them in the same way as incoming messages (See **Message playback**).

### To record a memo:

1. When the handset is in idle mode, press **MENU** to enter the main menu.
2. Press **∨** or **∧** on the handset, or **CALLER ID/∨** or **PHONEBOOK/∧** on the telephone base to scroll to **Answering sys**, then press **SELECT**.
3. Press **∨** or **∧** on the handset, or **CALLER ID/∨** or **PHONEBOOK/∧** on the telephone base to highlight **Record memo**, then press **SELECT**. The system announces, *"Record after the tone. Press STOP when you are done."*
4. Speak towards the handset to record a memo.
5. Press **STOP** to stop recording. The system announces, *"Recorded."* and then returns to the previous menu.

#### 📌NOTES

- The system will announce *"Memory is full"* if you record a memo when the memory is full.
- Memos shorter than two seconds are not recorded.

## Remote access

A two-digit security code is required to access the answering system remotely from any touch-tone telephone. The preset code is **19**. You can use this preset code, or set your own.

1. Dial your telephone number from any touch-tone telephone.
2. When the system plays your announcement, enter the two-digit security code.
3. You can enter one of the following remote commands.

Command	Description
<b>1</b>	Play all messages.
<b>2</b>	Play new messages.
<b>3</b>	Delete the current message (during playback).
<b>33</b>	Delete all old messages.
<b>4</b>	Repeat the current message (during playback).
<b>5</b>	Stop.
<b>*5</b>	Hear a list of remote commands.
<b>6</b>	Skip to the next message (during playback).
<b>*7</b>	Record a new announcement.
<b>8</b>	End the call.
<b>0</b>	Turn the answering system on or off.

4. Hang up or press **8** to end the call.

### NOTES

- If you do not press any keys after you enter the remote access code, all new messages play. If there are no new messages, all old messages play.

- Once the new messages have played, the telephone announces the help menu options. If you do not press any key within 20 seconds, the remote access call automatically disconnects.
- When the answering system memory is full, the telephone announces, "Memory is full. Enter the remote access code."

## Set remote access code

A two-digit security code is required to access the answering system remotely from any touch-tone telephone. The preset code is **19**. You can set the code from **00** to **99**.

1. When the handset is in idle mode, press **MENU** to enter the main menu.
2. Press **∨** or **∧** on the handset, or **CALLER ID/∨** or **PHONEBOOK/∧** on the telephone base to scroll to **Answering sys**, then press **SELECT**.
3. Press **∨** or **∧** on the handset, or **CALLER ID/∨** or **PHONEBOOK/∧** on the telephone base to scroll to **Ans sys setup**, then press **SELECT**.
4. Press **∨** or **∧** on the handset, or **CALLER ID/∨** or **PHONEBOOK/∧** on the telephone base to scroll to **Remote code**, then press **SELECT**.
5. Use the dialing keys to enter a two-digit number. Press **MUTE/DELETE** to backspace and delete a digit.
6. Press **SAVE** to save the setting. You hear a confirmation tone.

## Call screening

### To screen a call at the telephone base:

If the answering system and call screening are turned on, the announcement and the incoming message broadcast at the telephone base while the call is answered by the answering system.

### Options while a message is being recorded:

- Press **▼/VOL/▲** on the telephone base to adjust the call screening volume.
- Press **▶/■/PLAY/STOP** or **SILENCE** to temporarily silence the call screening.
- Press **▶/■/PLAY/STOP** or **SCREEN** to temporarily turn on the call screening if call screening is set to off.
- Press **HOME** to answer the call.

### To screen a call at a handset:

If the answering system is on and your answering system is recording a message, press **SCREEN** to screen the call on your handset and the screen displays the caller ID information. If you do not subscribe to caller ID service, the handset shows **Home Incoming call**.

### Options while a message is being recorded:

- Press **VOLUME/⌵** or **VOLUME/⌶** to adjust the call screening volume.
- Press **CANCEL** or **SILENCE** to temporarily silence the call screening.
- Press **SCREEN** to temporarily turn on the call screening if call screening is set to off.

- Press **▶/■** to broadcast the announcement and the incoming message through the speakerphone. Press again to turn off the speakerphone.

## Call intercept

If you want to talk to the caller whose message is being recorded, press **HOME** or **▶/■** on the handset, or press **HOME** on the telephone base.

## Using your built-in answering system and voicemail service

You can use your answering system and voicemail service together by setting your answering system to answer before voicemail service answers as described below. To learn how to program your voicemail settings, contact your telephone service provider.

If you are on a call, or if the answering system is busy recording a message and you receive another call, the second caller can leave a voicemail message.

Set your answering system to answer calls at least two rings earlier than your voicemail service is set to answer. For example, if your voicemail service answers after six rings, set your answering system to answer after four rings. Some voicemail service providers may program the delay before answering calls in seconds instead of rings. In this case, allow six seconds per ring when determining the appropriate setting.

## Retrieve voicemail from telephone service

Voicemail is a feature available from most telephone service providers. It may be included with your telephone service, or may be optional. Fees may apply.

### Retrieve voicemail

When you received a voicemail, the handset displays **New voicemail** and .

To retrieve, you typically dial an access number provided by your telephone service provider, and then enter a security code. Contact your telephone service provider for instructions on how to configure the voicemail settings and listen to messages.

## Turn off then new voicemail indicators

If you have retrieved your voicemail while away from home, and the handset and the telephone base still display the new voicemail indicators, use this feature to turn off the indicators.

### NOTE

This feature turns off the indicators only, it does not delete your voicemail messages.

1. Press **MENU** when in idle mode to enter the main menu.
2. Press **∨** or **∧** on the handset, or **CALLER ID/ ∇** or **PHONEBOOK/ ▲** on the telephone base to scroll to **Settings**, then press **SELECT**.
3. Press **∨** or **∧** on the handset, or **CALLER ID/ ∇** or **PHONEBOOK/ ▲** on the telephone base to scroll to **Clear voicemail**, then press **SELECT**. The screen shows **Reset Voicemail Indication?**
4. Press **YES** to turn the voicemail indication off. There is a confirmation tone and the screen returns to the previous menu.

## Cell phone voicemail

If you have voicemail service active on your cell phone, and you do not answer the incoming cell call, the call will be answered by your cell phone's voicemail. Contact your cell phone service provider for more information about voicemail service.

## Expand your telephone system

You can add new handsets (**DS6290**), cordless headsets or speakerphones to your telephone system (purchased separately) to your telephone system. Visit [www.vtechphones.com](http://www.vtechphones.com) for a list of compatible devices. Your telephone base supports a maximum of 12 devices.

For more details, refer to the user's manual that comes with your **DS6290** new handset, cordless headset or speakerphone respectively.

## Screen messages

BASE 0 is calling	The telephone base is calling.
BASE 0 is calling all	The telephone base is calling all devices (for intercom calls).
Bluetooth system busy	You are trying to make a cell call or access the Bluetooth menu when the Bluetooth link is already being used.
Call transferred	You have transferred an outside call to another device.
Caller ID log empty	There are no entries in the caller ID log.
Calling BASE 0	The handset is calling the telephone base (for intercom calls).
Calling HANDSET X	The handset or telephone base is calling another handset (for intercom calls). The telephone base is transferring an outside call to a handset.
Cell	The cell line is on a call.
Cell call on hold	A call on the cell line has been put on hold

Cell line in use	Another system handset is using the cell line.
Cell 1/2 alert: XXX	The Android phone that you paired with this telephone received a mobile notification.
Cell 1/2 low batt	Message received from Alerts manager that your cell phone's battery is low.
Connection failed	A Bluetooth device failed to establish a connection with your telephone system.
Contact deleted	A directory entry is deleted.
Directory empty	There are no directory entries.
Directory full	The directory is full. You cannot save any new entries unless you delete some current entries.
Downloading...	The system is downloading a directory from a cell phone.
Ended	You have just ended a call.
HANDSET X is calling	Another system handset is calling.
HANDSET X is calling all	The handset is calling all devices.
Home	The home line is on a call.
Home call on hold	A call on the home line has been put on hold.

Home & cell calls on hold	Calls on the home and cell lines have been put on hold.
Home & cell lines in use	Calls on the home and cell lines are being used.
Home line in use	A system handset or another telephone on the same home line is in use.
Incoming call	There is a call coming in.
Intercom	The device is on an intercom call.
Intercom ended	The intercom call has just ended.
Line in use	An extension phone, or one of the devices is in use.
Low battery	The battery is low. You should charge the battery.
Microphone ON	Mute is off so the other party can hear your voice.
Muted	The microphone is off. The other party cannot hear you.
New voicemail	There are new voicemail messages from your telephone service provider.
No answer. Try again	The device(s) you are trying to transfer a call to is out of range, off hook, or has no power.

No battery	The handset in the charger has no battery installed.
No Bluetooth device is ready for connection	There is no Bluetooth device paired to the telephone system when you press <b>CELL 1/CELL 2</b> on the telephone base or handset.
No caller info	The caller information is unavailable.
No home line	There is no telephone line connection.
No entries found. Download from SIM only?	There are no entries found when you download a cell phone directory from the cell memory.
No entries found. Download from Phone only?	There are no entries found when you download a cell phone directory from your SIM card.  There are no entries found in either the cell or SIM card when you download a cell phone directory from both memories.
No messages	There are no messages in the answering system.

No PTT call	The incoming PTT function is turned off. The handset will not receive PTT calls.
No signal, Call ended.	The phone lost connection with the telephone base or did not have a strong enough signal and the phone call ended.
Not available at this time	Someone else is already using the directory or caller ID log.  When a handset tries to access the answering system or Bluetooth menu during battery backup mode.
Number already saved	The telephone number you have entered is already in the directory.
Out of range OR no power at base	The telephone base has lost power, or the handset is out of range.
** Paging **	The cordless handset is paged by the telephone base.
Paging all devices	The telephone base is paging all devices.
Place in charger	The battery is very low. The handset should be charged.



FTT From HANDSET X To devices: X	One handset has started a PTT session to another handset and telephone base.
FTT From HANDSET X To devices: X	One handset has started a PTT session to another handset.
FTT To HANDSET X	You have started the PTT process with a handset.
FTT To BASE 0	You have started the PTT process with the telephone base.
Push to talk Ended	The PTT session is ended.
Quiet mode on	QUIET mode is on.
Quiet mode is off	QUIET mode is turned off.
Rec mem full	The system recording time is full.
Rec mem low	The system recording time is low.
Registering... Please wait	The handset is registering to the telephone base.
Registration slots are full	The telephone base has the maximum of 12 handsets registered to it.
Registration failed	The handset registration is not successful.
Ringer off	The ringer is turned off.

Ringer muted	The ringer is off temporarily while the device is ringing.
Saved	An entry has been successfully saved in the directory.
To register PB, see manual.	Screen display before handset registration.
Unable to call. Try again	You try to join a call when there are already four handsets on that call.  You try to make an outside call when another device is transferring a call with the intercom feature.
XX Missed calls	There are new calls in the caller ID log.
XX New msgs	Displays on handset screen when you have new messages in the answering system.
XX New messages	Displays on telephone base screen when you have new messages in the answering system.

## **ECO mode**

This power conserving technology reduces power consumption for optimal battery performance. The ECO mode activates automatically whenever the handset is synchronized with the telephone base.

The handset shows **ECO** when the ECO mode activates.

## **General product care**

### **Taking care of your telephone**

Your cordless telephone contains sophisticated electronic parts, so it must be treated with care.

### **Avoid rough treatment**

Place the handset down gently. Save the original packing materials to protect your telephone if you ever need to ship it.

### **Avoid water**

Your telephone can be damaged if it gets wet. Do not use the handset outdoors in the rain, or handle it with wet hands. Do not install the telephone base near a sink, bathtub or shower.

### **Electrical storms**

Electrical storms can sometimes cause power surges harmful to electronic equipment. For your own safety, take caution when using electrical appliances during storms.

### **Cleaning your telephone**

Your telephone has a durable plastic casing that should retain its luster for many years. Clean it only with a dry non-abrasive cloth. Do not use dampened cloth or cleaning solvents of any kind.

# Frequently asked questions

Below are the questions most frequently asked about the cordless telephone. If you cannot find the answer to your question, visit our website at [www.vtechphones.com](http://www.vtechphones.com) or call **1 (800) 595-9511** for customer service.

<p>My telephone does not work at all.</p>	<p>Make sure the telephone base is installed properly, and battery is installed and charged correctly. For optimum daily performance, return the handset to the telephone base after use.</p>
<p>The display shows <b>No home line</b>. I cannot hear the dial tone.</p>	<p>Disconnect the telephone line cord from your telephone and connect it to another telephone. If there is no dial tone on that other telephone either, then the telephone line cord may be defective. Try installing a new telephone line cord.</p> <p>If changing telephone line cord does not help, the wall jack (or the wiring to this wall jack) may be defective. Contact your telephone service provider.</p> <p>You may be using a new cable or VoIP service, the existing telephone jacks in your home may no longer work. Contact your service provider for solutions.</p>

<p>I cannot dial out.</p>	<p>Make sure there is a dial tone before dialing. It is normal if the handset takes a second or two to synchronize with the telephone base before producing a dial tone. Wait an extra second before dialing.</p>
	<p>Eliminate any background noise. Mute the handset before dialing, or dial from another room in your home with less background noise.</p>
<p>The display shows <b>To register HS</b>, see manual. The handset does not work at all.</p>	<p>The handset is deregistered from the telephone base. Place the handset in the telephone base to register it back. The handset and telephone base show <b>HANDSET X Registered</b> and you hear a beep when the registration process completes. This process takes about 90 seconds to complete.</p>
<p>The display shows <b>Low battery</b>.</p>	<p>Place the handset in the telephone base or charger for charging.</p>
<p>The battery does not charge in the handset or the handset battery does not accept charge.</p>	<p>Make sure the handset is placed in the telephone base or charger correctly.</p> <p>If the battery is completely depleted, charge the battery for at least 30 minutes before use.</p> <p>You may need to purchase a new battery.</p>
<p>The telephone does not ring when there is an incoming call.</p>	<p>Make sure the ringer volume is not set to off.</p> <p>The handset may be too far from the telephone base. Move it closer to the telephone base.</p>
<p>My handset beeps and is not performing normally.</p>	<p>Move the handset closer to the telephone base. It may be out of range.</p>

I hear other calls when using the telephone.	Disconnect the telephone base from the telephone wall jack. Plug in a different telephone. If you still hear other calls, the problem is probably in the wiring or telephone service. Contact your telephone service provider.
I hear noise on the cordless handset and the keys do not work.	Make sure the telephone line cord is plugged in securely.
There is interference during a telephone conversation. My calls fade out when I am using the cordless handset.	The handset may be out of range. Move it closer to the telephone base.
	If you subscribe to high-speed Internet service (DSL - digital subscriber line) through your telephone line, you must install a DSL filter between the telephone line cord and the telephone wall jack. The filter prevents noise and caller ID problems caused by DSL interference. Contact your DSL service provider for more information about DSL filters.
	Appliances or other cordless telephones plugged into the same circuit as the telephone base can cause interference. Try moving the appliance or telephone base to another outlet.
	The location of your telephone base can impact the performance of your cordless phone. For better reception, install the telephone base in a centralized location within your home or office, away from walls or other obstructions. In many environments, elevating the telephone base improves overall performance.

The telephone does not receive caller ID or the telephone does not show caller ID during call waiting.	Caller ID is a subscription service. You must subscribe to this service from your telephone service provider for this feature to work on your telephone.
	Both your and the caller's telephone service providers must use equipment compatible with the caller ID service.
	The caller may not be calling from an area which supports caller ID.
	The caller ID information displays after the first or second ring.
The display shows <b>Out of range OR no power at base</b> and <b>Put HS on base to power base</b> alternately.	The handset may be out of range. Move it closer to the telephone base.
	Make sure the power cord is securely plugged into the telephone base. Use a working electrical outlet not controlled by a wall switch.

I subscribe to a nontraditional telephone service that uses my computer to establish connections, and my telephone doesn't work.	Make sure your computer is powered on, and your Internet is working properly.	The answering system does not announce the correct day of the week for recorded messages time stamp.	Make sure you have set the date and time. See <b>Configure your telephone</b> section.
	Make sure to plug your USB telephone adapter into a dedicated USB port on your computer. Do not plug into a multiple port USB hub (USB splitter) that is not powered.		
	In a few rare instances, the USB port on your computer may not have enough power. In these instances, try using a USB hub with its own external power supply.		
	If you are using a firewall, it may prevent access to your nontraditional telephone service. Contact your service provider for more information.		
The answering system does not record messages.	Make sure the answering system is on. When the answering system is on, <b>ANS ON</b> should display on the handset and the telephone base.	The messages on the answering system are incomplete.	If a caller leaves a very long message, part of it may be lost when the answering system disconnects the call after the preset recording time.  If the memory on the answering system becomes full during a message, the answering system stops recording and disconnects the call.
	When the answering machine memory is full, it does not record new messages until some old messages are deleted.		
	If you subscribe to voicemail service, change the number of rings so that your answering system answers before your voicemail service answers. To determine how many rings activate your voicemail service, contact your telephone service provider.	I accidentally set my LCD language to Spanish or French, and I don't know how to change it back to English.	While the handset is not in use or is on a call, press <b>MENU</b> and then enter <b>*364#</b> to change the handset LCD language back to English.

## The RBRC® seal

The RBRC® seal on the nickel-metal hydride battery indicates that VTech Communications, Inc. is voluntarily participating in an industry program to collect and recycle these batteries at the end of their useful lives, when taken out of service within the United States and Canada.

The RBRC® program provides a convenient alternative to placing used nickel-metal hydride batteries into the trash or municipal waste, which may be illegal in your area.

VTech's participation in RBRC® makes it easy for you to drop off the spent battery at local retailers participating in the RBRC® program or at authorized VTech product service centers. Please call **1 (800) 8 BATTERY®** for information on Ni-MH battery recycling and disposal bans/restrictions in your area. VTech's involvement in this program is part of its commitment to protecting our environment and conserving natural resources.

**RBRC® and 1 (800) 8 BATTERY® are registered trademarks of the Rechargeable Battery Recycling Corporation.**



## FCC, ACTA and IC regulations

### FCC Part 15

This equipment has been tested and found to comply with the requirements for a Class B digital device under Part 15 of the Federal Communications Commission (FCC) rules. These requirements are intended to provide reasonable protection against harmful interference in a residential installation. This equipment generates, uses and can radiate radio frequency energy and, if not installed and used in accordance with the instructions, may cause harmful interference to radio communications. However, there is no guarantee that interference will not occur in a particular installation. If this equipment does cause harmful interference to radio or television reception, which can be determined by turning the equipment off and on, the user is encouraged to try to correct the interference by one or more of the following measures:

- Reorient or relocate the receiving antenna.
- Increase the separation between the equipment and receiver.
- Connect the equipment into an outlet on a circuit different from that to which the receiver is connected.
- Consult the dealer or an experienced radio/TV technician for help.

Changes or modifications to this equipment not expressly approved by the party responsible for compliance could void the user's authority to operate the equipment.

This device complies with Part 15 of the FCC rules. Operation is subject to the following two conditions: (1) this device may not cause harmful interference, and

(2) this device must accept any interference received, including interference that may cause undesired operation. Privacy of communications may not be ensured when using this telephone.

To ensure safety of users, the FCC has established criteria for the amount of radio frequency energy that can be safely absorbed by a user or bystander according to the intended usage of the product. This product has been tested and found to comply with the FCC criteria. The handset may be safely held against the ear of the user. The telephone base shall be installed and used such that parts of the user's body other than the hands are maintained at a distance of approximately 20 cm (8 inches) or more.

This Class B digital apparatus complies with Canadian requirement:

CAN ICES-3 (B)/NMB-3(B)

## **FCC Part 68 and ACTA**

This equipment complies with Part 68 of the FCC rules and with technical requirements adopted by the Administrative Council for Terminal Attachments (ACTA). The label on the back or bottom of this equipment contains, among other things, a product identifier in the format US: AAAEQ##TXXXX. This identifier must be provided to your telephone service provider upon request.

The plug and jack used to connect this equipment to premises wiring and the telephone network must comply with applicable Part 68 rules and technical requirements adopted by ACTA. A compliant telephone cord and modular plug is provided with this product. It is designed to be connected to a compatible modular jack that is also compliant. An RJ11 jack should normally be used for

connecting to a single line and an RJ14 jack for two lines. See the installation instructions in the user's manual.

The Ringer Equivalence Number (REN) is used to determine how many devices you may connect to your telephone line and still have them ring when you are called. The REN for this product is encoded as the 6th and 7th characters following the US: in the product identifier (e.g., if ## is 03, the REN is 0.3). In most, but not all areas, the sum of all RENs should be five (5.0) or less. For more information, contact your telephone service provider.

This equipment may not be used with Party Lines. If you have specially wired alarm dialing equipment connected to your telephone line, ensure the connection of this equipment does not disable your alarm equipment. If you have questions about what will disable alarm equipment, consult your telephone service provider or a qualified installer.

If this equipment is malfunctioning, it must be unplugged from the modular jack until the problem has been corrected. Repairs to this telephone equipment can only be made by the manufacturer or its authorized agents. For repair procedures, follow the instructions outlined under the Limited warranty.

If this equipment is causing harm to the telephone network, the telephone service provider may temporarily discontinue your telephone service. The telephone service provider is required to notify you before interrupting service. If advance notice is not practical, you will be notified as soon as possible. You will be given the opportunity to correct the problem and the telephone service provider is required to inform you of your right to file a complaint with the FCC. Your telephone service provider may make changes in its facilities,

equipment, operation, or procedures that could affect the proper functioning of this product. The telephone service provider is required to notify you if such changes are planned.

If this product is equipped with a corded or cordless handset, it is hearing aid compatible.

If this product has memory dialing locations, you may choose to store emergency telephone numbers (e.g., police, fire, medical) in these locations. If you do store or test emergency numbers, please:

Remain on the line and briefly explain the reason for the call before hanging up. Perform such activities in off-peak hours, such as early morning or late evening.

## Industry Canada

Operation is subject to the following two conditions: (1) this device may not cause harmful interference, and (2) this device must accept any interference received, including interference that may cause undesired operation.

Privacy of communications may not be ensured when using this phone.

The term "IC:" before the certification/registration number only signifies that the Industry Canada technical specifications were met.

The Ringer Equivalence Number (REN) for this terminal equipment is 0.1. The REN is an indication of the maximum number of devices allowed to be connected to a telephone interface. The termination on an interface may consist of any combination of devices subject only to the requirement that the sum of the RENs of all the devices does not exceed five.

This product meets the applicable Industry Canada technical specifications.

# California Energy Commission battery charging testing instructions

This telephone is set up to comply with the energy-conserving standards right out of the box. These instructions are intended for California Energy Commission (CEC) compliance testing only.

When the CEC battery charging testing mode is activated, all telephone functions, except battery charging, will be disabled.

### To activate the CEC battery charging testing mode:

1. Unplug the telephone base power adapter from the power outlet. Make sure all handsets are plugged with charged batteries before proceeding.
2. While you **press and hold** **🔍/FIND HANDSET**, plug the telephone base power adapter back to the power outlet.
3. After about 20 seconds, when the **🏠/HOME** light starts flashing, release **🔍/FIND HANDSET** and then press it again within 2 seconds.

The process takes up to one minute to complete. When the phone successfully enters the CEC battery charging testing mode, the **🏠/HOME** light turns off and all handsets display **To register HS, see manual**.

When the phone fails to enter this mode, repeat Step 1 through Step 3 above. The telephone base will be powered up as normal if you fail to press **🔍/FIND HANDSET** within 2 seconds in Step 3.

### To deactivate the CEC battery charging testing mode:

1. Unplug the telephone base power adapter from the power outlet, and then plug it back in. Then the telephone base is powered up as normal.
2. Place the handset in the telephone base to register it back. The handset displays **Registering... Please wait**.

### NOTE

The handset and telephone base show **HANDSET X Registered** and you hear a beep when the registration process completes. This process takes about 90 seconds to complete.



# For C-UL compliance only

## Mesures de sécurité importantes

Afin de réduire les risques d'incendie, de blessures corporelles ou d'électrocution, suivez toujours ces mesures préventives de base lorsque vous utilisez votre téléphone :

1. Lisez et comprenez bien toutes les instructions.
2. Observez toutes les instructions et mises en garde inscrites sur l'appareil.
3. Débranchez ce téléphone de la prise murale avant de le nettoyer. N'utilisez pas de nettoyeurs liquides ni en aérosol. N'utilisez qu'un chiffon doux et légèrement humecté.
4. N'utilisez pas ce produit près de l'eau, tel que près d'un bain, d'un lavabo, d'un évier de cuisine, d'un bac de lavage ou d'une piscine, ou dans un sous-sol humide ou sous la douche.
5. Ne déposez pas ce téléphone sur un chariot, support ou table chancelants. L'appareil pourrait tomber et être sérieusement endommagé.
6. Le boîtier de l'appareil est doté de fentes et d'ouvertures d'aération situées à l'arrière ou en dessous. Afin d'empêcher la surchauffe, ces ouvertures ne doivent pas être obstruées en plaçant l'appareil sur un lit, divan, tapis ou autre surface similaires. Ne placez pas cet appareil à proximité d'un élément de chauffage ni d'une plinthe électrique. De plus, ne l'installez pas dans une unité murale ou un cabinet fermé qui ne possède pas d'aération adéquate.
7. Ne faites fonctionner cet appareil qu'avec le type d'alimentation indiqué sur les étiquettes de l'appareil. Si vous ne connaissez pas le voltage de votre maison, consultez votre marchand ou votre fournisseur d'électricité.
8. Ne déposez rien sur le cordon d'alimentation. Installez cet appareil dans un endroit sécuritaire, là où personne ne pourra trébucher sur la ligne d'alimentation ni le cordon téléphonique modulaire.
9. N'insérez jamais d'objets à travers les fentes et ouvertures de cet appareil, car ils pourraient toucher à des points de tension dangereux ou court-circuiter des pièces, ce qui constituerait un risque d'incendie ou d'électrocution. N'échappez pas de liquides dans l'appareil.
10. Afin de réduire les risques d'électrocution, ne démontez pas l'appareil, mais apportez-le plutôt à un centre de service qualifié s'il doit être réparé. En enlevant le couvercle, vous vous exposez à des tensions dangereuses ou autres dangers similaires. Un remontage inadéquat peut être à l'origine d'une électrocution lors d'une utilisation ultérieure de l'appareil. Débranchez l'appareil avant de procéder au nettoyage. Utilisez un chiffon humide et doux.
11. Ne surchargez pas les prises de courant et les rallonges.
12. Débranchez cet appareil de la prise de courant et communiquez avec le département de service à la clientèle de VTech dans les cas suivants:
  - Lorsque le cordon d'alimentation est endommagé ou écorché.
  - Si du liquide a été échappé dans l'appareil.
  - Si l'appareil a été exposé à une source d'humidité telle que la pluie ou l'eau.

- Si le produit ne fonctionne pas
  - normalement en respectant les instructions de fonctionnement. Réglez uniquement les commandes indiquées dans les instructions de fonctionnement. Les réglages incorrects des autres commandes pourraient provoquer un dommage qui pourrait exiger un travail exhaustif de la part d'un technicien autorisé afin de rétablir le fonctionnement normal de l'appareil.
  - Si le produit a été échappé et que le socle et/ou le combiné a été endommagé.
  - Si le produit affiche une nette diminution de sa performance.
13. Évitez d'utiliser un téléphone (autre qu'un sans fil) pendant un orage. Les éclairs peuvent être à l'origine d'une électrocution.
14. N'utilisez pas le téléphone pour rapporter une fuite de gaz à proximité de la fuite. En certaines circonstances, une flammèche pourrait être provoquée lorsque l'adaptateur est branché à une prise de courant, ou lorsque le combiné est déposé sur le socle. Ceci est un événement commun associé à la fermeture d'un circuit électrique. L'utilisateur ne devrait pas brancher le téléphone à une prise de courant, et ne devrait pas déposer le combiné chargé sur le socle, si le téléphone se trouve à proximité d'un endroit comportant des concentrations de gaz inflammables, à moins que la ventilation soit adéquate. Une flammèche dans un tel endroit pourrait provoquer un incendie ou une explosion. De tels environnements peuvent comprendre: des endroits où l'on utilise de l'oxygène médical sans ventilation adéquate; des gaz industriels (dissolvants de nettoyage, des vapeurs d'essence, etc.); une fuite de gaz naturel, etc.
15. Ne placez que le combiné de votre téléphone près de votre oreille lorsqu'en mode de conversation.
16. Ces adaptateurs ont été conçus pour être orientés en position verticale ou montés au sol. Les broches ne sont pas conçues pour maintenir l'adaptateur en place si celui-ci est branché dans une prise au plafond ou sous une table/ armoire.

## **CONSERVEZ CES INSTRUCTIONS**

### **Pile**

- **MISE EN GARDE** : Risque d'explosion si la pile est remplacée par une pile de types incorrects. Jetez les piles épuisées en respectant les instructions.
- Ne jetez pas la pile au feu. Vérifiez les instructions spécifiques de mise aux rebus auprès des autorités locales.
- N'ouvrez pas et ne mutilez pas la pile. L'électrolyte qui s'en échapperait est corrosif et pourrait causer des brûlures ou des blessures aux yeux ou à la peau. L'électrolyte est toxique si avalé.
- Soyez prudents lorsque vous manipulez les piles afin d'éviter les courts-circuits provoqués par des matériaux conducteurs.
- Rechargez la pile incluse avec cet appareil, selon les instructions et limites spécifiées dans ce guide d'utilisation.

### **Stimulateurs cardiaques implantés dans l'organisme**

Les simulateurs cardiaques (s'applique uniquement aux téléphones numériques sans fil):

L'organisme 'Wireless Technology Research, LLC (WTR)', une firme de recherche indépendante, a mené une évaluation pluridisciplinaire des interférences entre les téléphones sans fil portatifs et les stimulateurs cardiaques implantés dans l'organisme. Appuyée par l'Administration des aliments et drogues (FDA) des États-Unis, la firme WTR recommande aux médecins:

### **Avis aux détenteurs de stimulateurs cardiaques**

- Ils doivent tenir le téléphone sans fil à une distance d'au moins six pouces du stimulateur cardiaque.
- Ils ne doivent PAS placer le téléphone sans fil directement sur le stimulateur cardiaque, tel que dans une poche de chemise, lorsque celui-ci est en marche.
- Ils doivent utiliser le téléphone sans fil en l'appuyant sur l'oreille qui se trouve dans la direction opposée au stimulateur cardiaque.

L'étude effectuée par l'organisme WRS n'a pas identifié de risque pour les détenteurs de simulateurs cardiaques causés par les gens qui utilisent un téléphone sans fil à proximité de ceux-ci.

### **À propos des téléphones sans fil**

- **Alimentation électrique:** Les mêmes caractéristiques qui constituent des avantages pour les téléphones sans fil affichent également des restrictions. Les appels téléphoniques sont transmis entre le combiné sans fil et le socle par le biais d'ondes radio ; il y a donc la possibilité que vos conversations téléphoniques sans fil soient interceptées par des équipements de réception radio se trouvant dans la portée du

combiné sans fil. Pour cette raison, vous ne devez pas percevoir les communications téléphoniques sans fil comme étant aussi confidentielles.

- **Alimentation électrique:** Le socle de ce téléphone sans fil doit être branché à une prise électrique fonctionnelle. La prise électrique ne doit pas être contrôlée par un interrupteur mural. Les appels ne pourront pas être effectués du combiné sans fil si le socle est débranché ou mis hors tension ou si le courant est coupé.
- **Possibilité d'interférences aux téléviseurs:** Certains téléphones sans fil fonctionnent sur des fréquences pouvant causer des interférences aux téléviseurs et aux magnétoscopes. Pour réduire ou prévenir de telles interférences, ne placez pas le socle du téléphone sans fil près ou sur un téléviseur ou magnétoscope. S'il y a présence de parasites, il est conseillé d'éloigner le téléphone sans fil du téléviseur ou du magnétoscope afin de réduire possiblement les interférences.
- **Piles rechargeables:** Manipulez les piles avec soin afin de ne pas les court-circuiter avec des bagues, bracelets ou clés. Les piles ou le conducteur peut surchauffer et causer des blessures. Respectez la polarité adéquate entre la pile et le chargeur.
- **Les bloc-piles rechargeables à l'hydrure métallique de nickel:** Jetez ces blocs-piles de manière écologique et sécuritaire. Ne les incinerez pas et ne les percez pas. Tel que les autres piles de ce type, elles pourraient dégager une matière toxique qui peut causer des blessures corporelles si elles sont brûlées ou percées.

# Limited Warranty

## What does this limited warranty cover?

The manufacturer of this VTech Product warrants to the holder of a valid proof of purchase (“Consumer” or “you”) that the Product and all accessories provided in the sales package (“Product”) are free from defects in material and workmanship, pursuant to the following terms and conditions, when installed and used normally and in accordance with the Product operating instructions. This limited warranty extends only to the Consumer for Products purchased and used in the United States of America and Canada.

## What will VTech do if the Product is not free from defects in materials and workmanship during the limited warranty period (“Materially Defective Product”)?

During the limited warranty period, VTech’s authorized service representative will repair or replace at VTech’s option, without charge, a Materially Defective Product. If we repair the Product, we may use new or refurbished replacement parts. If we choose to replace the Product, we may replace it with a new or refurbished Product of the same or similar design. We will retain defective parts, modules, or equipment. Repair or replacement of the Product, at VTech’s option, is your exclusive remedy. VTech will return the repaired or replacement Products to you in working condition. You should expect the repair or replacement to take approximately 30 days.

## How long is the limited warranty period?

The limited warranty period for the Product extends for ONE (1) YEAR from the date of purchase. If VTech repairs or replaces a Materially Defective Product under the terms of this limited warranty, this limited warranty also applies to the repaired or replacement Product

for a period of either (a) 90 days from the date the repaired or replacement Product is shipped to you or (b) the time remaining on the original one-year warranty; whichever is longer.

## What is not covered by this limited warranty?

This limited warranty does not cover:

1. Product that has been subjected to misuse, accident, shipping or other physical damage, improper installation, abnormal operation or handling, neglect, inundation, fire, water or other liquid intrusion; or
2. Product that has been damaged due to repair, alteration or modification by anyone other than an authorized service representative of VTech; or
3. Product to the extent that the problem experienced is caused by signal conditions, network reliability, or cable or antenna systems; or
4. Product to the extent that the problem is caused by use with non-VTech accessories; or
5. Product whose warranty/quality stickers, product serial number plates or electronic serial numbers have been removed, altered or rendered illegible; or
6. Product purchased, used, serviced, or shipped for repair from outside the United States of America or Canada, or used for commercial or institutional purposes (including but not limited to Products used for rental purposes); or
7. Product returned without a valid proof of purchase (see item 2 on the next page); or
8. Charges for installation or set up, adjustment of customer controls, and installation or repair of systems outside the unit.

## How do you get warranty service?

To obtain warranty service in the United States of America, please visit our website at [www.vtechphones.com](http://www.vtechphones.com) or call **1 (800) 595-9511**. In Canada, go to [www.vtechcanada.com](http://www.vtechcanada.com) or dial **1 (800) 267-7377**.

**NOTE:** Before calling for service, please review the user's manual - a check of the Product's controls and features may save you a service call.

Except as provided by applicable law, you assume the risk of loss or damage during transit and transportation and are responsible for delivery or handling charges incurred in the transport of the Product(s) to the service location. VTech will return repaired or replaced Product under this limited warranty. Transportation, delivery or handling charges are prepaid. VTech assumes no risk for damage or loss of the Product in transit. If the Product failure is not covered by this limited warranty, or proof of purchase does not meet the terms of this limited warranty, VTech will notify you and will request that you authorize the cost of repair prior to any further repair activity. You must pay for the cost of repair and return shipping costs for the repair of Products that are not covered by this limited warranty.

## What must you return with the Product to get warranty service?

1. Return the entire original package and contents including the Product to the VTech service location along with a description of the malfunction or difficulty; and
2. Include a "valid proof of purchase" (sales receipt) identifying the Product purchased (Product model) and the date of purchase or receipt; and
3. Provide your name, complete and correct mailing address, and telephone number.

## Other limitations

This warranty is the complete and exclusive agreement between you and VTech. It supersedes all other written or oral communications related to this Product. VTech provides no other warranties for this Product. The warranty exclusively describes all of VTech's responsibilities regarding the Product. There are no other express warranties. No one is authorized to make modifications to this limited warranty and you should not rely on any such modification.

**State/Provincial Law Rights:** This warranty gives you specific legal rights, and you may also have other rights, which vary from state to state or province to province.

**Limitations:** Implied warranties, including those of fitness for a particular purpose and merchantability (an unwritten warranty that the Product is fit for ordinary use) are limited to one year from the date of purchase. Some states/provinces do not allow limitations on how long an implied warranty lasts, so the above limitation may not apply to you. In no event shall VTech be liable for any indirect, special, incidental, consequential, or similar damages (including, but not limited to lost profits or revenue, inability to use the Product or other associated equipment, the cost of substitute equipment, and claims by third parties) resulting from the use of this Product. Some states/provinces do not allow the exclusion or limitation of incidental or consequential damages, so the above limitation or exclusion may not apply to you.

**Please retain your original sales receipt as proof of purchase.**

# Technical Specifications

---

Frequency control	Crystal controlled PLL synthesizer
Transmit frequency	DECT frequency: 1921.536-1928.448 MHz  Bluetooth frequency: 2402.000-2480.000MHz
Channels	DECT: 5  Bluetooth: 79
Nominal effective range	Maximum power allowed by FCC and IC. Actual operating range may vary according to environment conditions at the time of use.
Power requirements	Handset: 2.4V 400mAH AAAx2 Ni-MH battery  Telephone base: dual output, 6VDC @ 600mA; 5.1VDC @ 1000mA  Charger: 6V AC @ 300mA
Memory	Directory: Home line: 200 memory locations, up to 30 digits and 15 characters  Each cell line: 1500 memory locations, up to 30 digits and 15 characters  Caller ID log: 50 memory locations; up to 24 digits and 15 characters

---

The *Bluetooth*<sup>®</sup> word mark and logos are owned by Bluetooth SIG, Inc. and any use of such marks by VTech Holdings Limited is under license. VTech Holdings Limited is a member of Bluetooth SIG, Inc. Other trademarks and trade names are those of their respective owners.



Designed to fit your home.  
And your life.

VTech Communications, Inc.  
A member of THE VTECH GROUP OF COMPANIES.  
VTech is a registered trademark of VTech Holdings Limited.  
Specifications are subject to change without notice.  
Copyright © 2016 for VTech Communications, Inc.  
All rights reserved. 04/16. DS6291-X\_WEBCIB\_V4.0  
Document order number: 91-007713-020-100

